

A050 and A250 Foundation Series Fire Alarm Control Unit Operation Guide

579-1405AC Rev C



1	Cautions, Warnings, and Regulatory Information.....	5
2	Introduction.....	6
3	User interface.....	7
3.1	Control unit buttons.....	7
3.1.1	ACK.....	7
3.1.2	SILENCE.....	7
3.1.3	RESET.....	8
3.1.4	WALK TEST.....	8
3.1.5	UP and DOWN.....	8
3.1.6	LEFT and RIGHT.....	8
3.1.7	ESC.....	8
3.1.8	ENTER.....	8
3.2	LED indicators and piezo.....	8
4	Operations.....	9
4.1	Alarm conditions (Fire or CO/PRI2).....	9
4.1.1	Recognizing an alarm condition.....	9
4.1.1.1	Alarm screen.....	9
4.2	Processing alarms.....	10
4.2.1	Acknowledging an alarm.....	10
4.2.2	Silencing an alarm.....	10
4.2.3	Resetting the system.....	10
4.3	Viewing the alarm condition details.....	10
4.4	Supervisory and trouble conditions.....	11
4.4.1	Recognizing a supervisory and a trouble condition.....	11
4.4.2	Processing supervisory and trouble conditions.....	12
4.4.3	Viewing the supervisory and trouble conditions details.....	12
5	Using the control unit's interface.....	13
5.1	Alphanumeric keypad.....	13
5.2	Cursor keys.....	13
5.3	ESC and ENTER keys.....	13
5.4	HELP key.....	14
5.5	Buzzer or audible signals.....	14
5.6	Assistant text composition.....	14
5.6.1	Single selection.....	15
5.6.1.1	Alphanumeric keypad.....	15
5.6.1.2	Cursor keys.....	15
5.6.1.3	ESC and ENTER keys.....	15
5.6.2	Startup sequence.....	15
5.6.2.1	Configuring the initial settings.....	15
5.6.2.2	Setting the control unit password.....	15
5.6.3	Screensaver screen.....	16
5.6.3.1	System normal.....	16
5.7	Main menu.....	17
5.8	MAIN screen.....	17
5.8.1	Access level.....	17
5.8.2	Control unit mode.....	18
5.8.3	Control unit name.....	18
5.8.4	Control unit activity.....	18
5.8.5	Control unit date and time.....	18

6	User access level.....	19
7	Program menu: programming from the control unit.....	21
7.1	Auto.....	21
7.1.1	Loop break verification.....	21
7.1.2	Double address checking.....	21
7.1.3	Automatic zones assignment.....	21
7.1.4	Scheme 1.....	21
7.1.5	Scheme 2.....	22
7.1.6	Scheme 3.....	22
7.1.7	Auto addressing flow.....	22
7.2	Device.....	23
7.3	Software (SW) zone.....	25
7.4	Outputs.....	25
7.4.1	NAC configuration.....	25
7.4.1.1	NAC name.....	25
7.4.1.2	Function type.....	25
7.4.1.3	Coding pattern.....	25
7.4.1.4	Zone assignment.....	26
7.4.1.5	Device assignment.....	26
7.4.1.6	Wiring class.....	26
7.4.1.7	EOL resistor.....	26
7.4.2	Programming the NAC output.....	26
7.4.3	Programming relay output.....	26
7.4.4	Configuring auxiliary output.....	27
7.5	Configuring the gateway module.....	27
7.5.1	Configuring the gateway IP settings.....	28
7.5.1.1	Configuring the STATIC IP Address:.....	28
7.5.1.2	Configuring the DYNAMIC IP Address:.....	28
7.5.2	Configure Central Station Receiver (Primary and Secondary Central Station).....	28
7.5.2.1	If IP or Cellular option is selected configure as follows:.....	28
7.5.2.2	If PSTN option is selected configure as follows:.....	29
7.5.3	Secondary central station.....	29
7.5.4	Gateway configuration.....	29
7.6	USB.....	29
7.6.1	Loading programming data.....	30
7.6.2	Loading JSON data.....	30
7.6.3	Saving the programming data.....	30
7.6.4	Saving the JSON data.....	30
7.6.5	Upgrading firmware.....	31
7.6.6	Saving the log data.....	31
7.6.7	Loading help files.....	31
7.7	System.....	31
7.7.1	Language selection.....	31
7.7.2	Enable screensaver.....	31
7.7.3	Wiring class selection.....	32
7.7.4	Enabling NFPA.....	32
7.7.5	Enabling city card.....	33
7.8	Default.....	33

7.9	Device mapping.....	33
7.10	NFC.....	33
8	Disable menu.....	34
8.1	Disabled list.....	34
8.1.1	Disabled zones.....	35
8.1.2	Disabled devices.....	35
8.1.3	Disabled system modules.....	35
8.2	Device.....	35
8.3	SW zone.....	36
8.4	Output.....	37
8.5	Annunciator.....	37
8.6	Gateway.....	37
9	Modify menu.....	38
9.1	Date and time.....	38
9.2	Clearing the log.....	39
9.3	Modifying the control unit password.....	39
9.4	Configuring the Gateway.....	39
10	Analyze.....	40
10.1	Loop.....	40
10.2	Device.....	40
10.3	Software zone.....	41
10.4	Output.....	41
10.4.1	NAC.....	41
10.4.2	Relay.....	42
10.4.3	City circuit.....	42
10.5	Annunciator.....	42
10.6	Gateway.....	42
10.7	Lamp test.....	42
10.8	Firmware version.....	42
10.9	Panel Info.....	42
11	View list.....	44
11.1	Disabled list.....	44
11.1.1	Viewing disabled zones.....	44
11.1.2	Viewing disabled devices.....	44
11.1.3	Viewing disabled system parts.....	44
11.2	Viewing the CO/PRI2 list.....	44
11.3	Viewing the Trouble list.....	45
11.4	Viewing the Supervisory list.....	45
11.5	Viewing the Zone in walk test.....	46
11.6	Viewing the Device in walk test.....	46
12	Viewing the log.....	47
13	Event driven screens.....	48
13.1	Alarm screen.....	48
13.2	CO/PRI2 screen.....	49
13.3	Trouble screen.....	50
13.4	Walk test screen.....	50

14	Diagnostics.....	51
14.1	Overview.....	51
14.2	Panel meter screen.....	51
14.3	Loop diagnostic screen.....	51
14.4	Keyboard test.....	51
14.5	NAC current consumption.....	51
15	Event list.....	52
16	Delays and threshold.....	54
16.1	Water flow retard.....	54
16.2	AC loss delay.....	54
16.3	Trouble reminder.....	54
16.4	Alarm reminder.....	54
17	Troubleshooting screens.....	55
18	Notice to users installers, AHJ, and other involved parties.....	57
18.1	Locating not addressed devices.....	57
18.2	Device replacement.....	57
18.3	Double addressed devices.....	58
19	Walk test.....	59

1 Cautions, Warnings, and Regulatory Information

READ AND SAVE THESE INSTRUCTIONS Follow the instructions in this installation manual. These instructions must be followed to avoid damage to this product and associated equipment. Product operation and reliability depend upon proper installation.



DO NOT INSTALL ANY AUTOCALL™ PRODUCT THAT APPEARS DAMAGED Upon unpacking your Autocall product, inspect the contents of the carton for shipping damage. If damage is apparent, immediately file a claim with the carrier and notify an authorized Autocall product supplier.



ELECTRICAL HAZARD Disconnect electrical field power when making any internal adjustments or repairs. All repairs should be performed by a representative or an authorized agent of your local Autocall product supplier.



STATIC HAZARD Static electricity can damage components. Handle as follows:

- Ground yourself before opening or installing components.
- Before installation, keep components wrapped in anti-static material at all times.



SULFURIC ACID WARNING Battery contains sulfuric acid, which can cause severe burns to the skin and eyes and can destroy fabric. Replace any leaking or damaged battery while wearing appropriate protective gear. If you come in contact with sulfuric acid, immediately flush skin or eyes with water for 15 minutes and seek immediate medical attention.

FCC RULES AND REGULATIONS – PART 15 This equipment has been tested and found to comply with the limits for a Class A digital device, pursuant to Part 15 of the FCC Rules. These limits are designed to provide reasonable protection against harmful interference when the equipment is operated in a commercial environment. This equipment generates, uses, and can radiate radio frequency energy and, if not installed and used in accordance with the instruction manual, may cause harmful interference to radio communications. Operation of this equipment in a residential area is likely to cause harmful interference in which case the user will be required to correct the interference at his own expense.

SYSTEM REACCEPTANCE TEST AFTER SOFTWARE CHANGES To ensure proper system operation, this product must be tested in accordance with NFPA-72, after any programming operation or change in site-specific software. Reacceptance testing is required after any change, addition or deletion of system components, or after any modification, repair or adjustment to system hardware or wiring. All components, circuits, system operations, or software functions known to be affected by a change must be 100% tested. In addition, to ensure that other operations are not inadvertently affected, at least 10% of initiating devices that are not directly affected by the change, up to a maximum of 50 devices, must also be tested and proper system operation verified. NFPA 72® is a registered trademark of the National Fire Protection Association.

2 Introduction

The A050-9101 and A250-9101 are addressable fire alarm control units (FACUs).

A050-9101 is a small one loop addressable control unit with the capacity for 50 devices and addressable points for each loop. You can wire each device or point with Class A or Class B wiring. The control unit supports two Notification Appliance Circuits (NACs). You can wire the NACs with Class A or Class B wiring.

A250-9101 is a comparatively big, one loop addressable control unit with the capacity for 250 devices and addressable points for each loop. You can wire each device or point with Class A or Class B wiring. The control unit supports four Notification Appliance Circuits (NACs). You can wire the NACs with Class A or Class B wiring.

Both control units support an internal or external gateway module for communication with the remote station or central station.

Both control units provide audible and visible indications during alarm, supervisory, or trouble conditions. If any of these conditions occur, the system activates the applicable notification appliances, respective LEDs, and the control unit piezo. The indications continue until an operator acknowledges the condition.

Note: From this point on, the A050-9101 and the A250-9101 control units are referred to as A250, unless stated otherwise.

3 User interface

The user interface is used to operate the FACU.

Figure 1: User interface

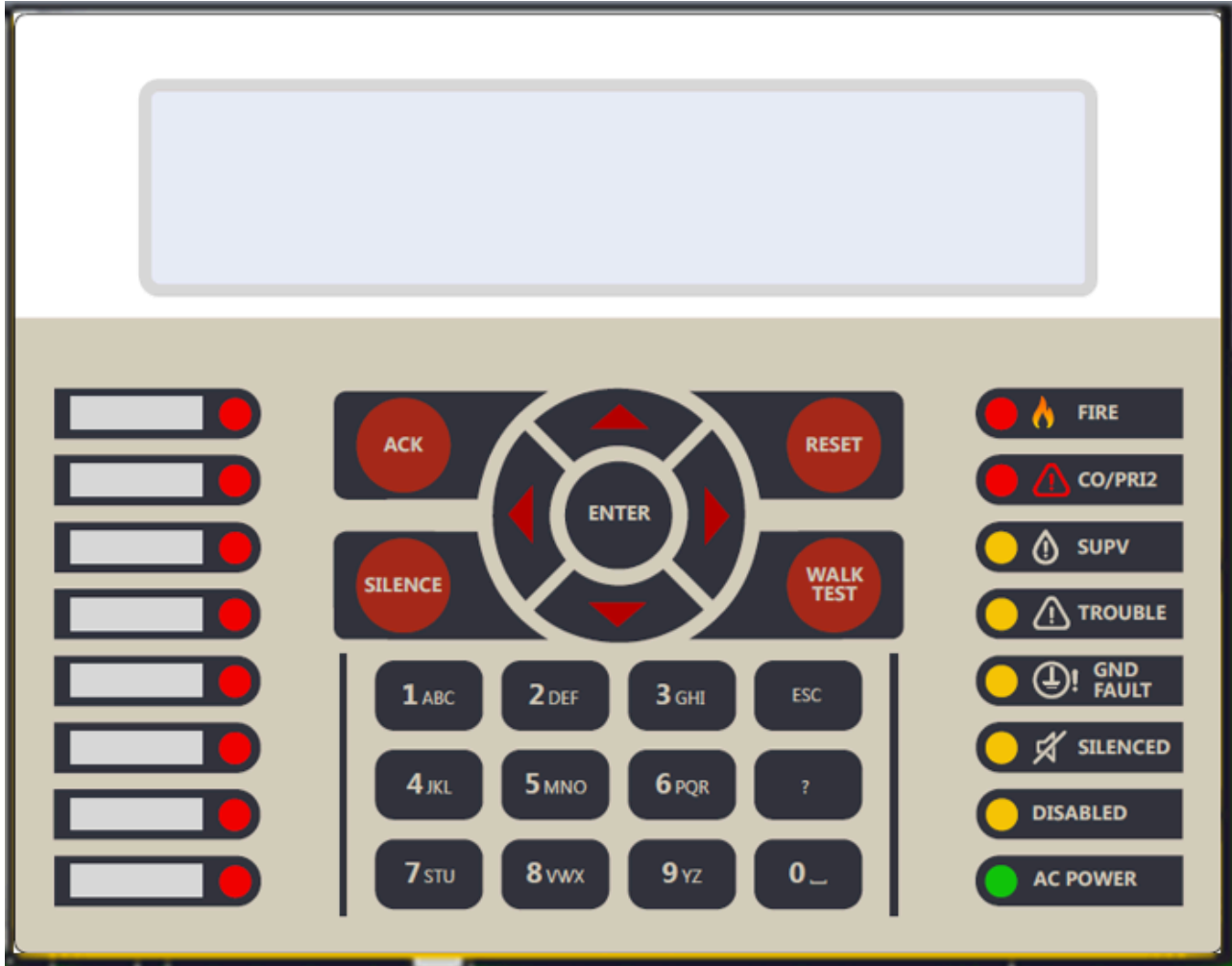

3.1 Control unit buttons

This section describes the function of the control unit's buttons.

3.1.1 ACK

Press **ACK** to silence the piezo sounder. The flashing LED changes to steady and the system sends acknowledge messages to the history file and system's display.

If you press **ACK**, the NACs configured for TROUBLE gets silenced, whereas it does not have any effects on NACs configured for other events.

3.1.2 SILENCE

If an alarm exists, press **SILENCE** to turn off all silenceable outputs, such as NACs. The system turns on the **SILENCED** LED. The system also sends an alarm silenced message to the history file and system's display.

3.1.3 RESET

Press **RESET** to complete the following actions:

- Reset all alarm notification appliances and controls.
- Remove alarms from the alarm list.
- Silence all silenceable outputs.
- Return the system to a normal state, provided that no alarm, supervisory or trouble conditions are present.

If any trouble exists after a reset, the NACs and piezo buzzer resound. If any alarm exists during RESET, the LCD screen shows the following:

ALARMS PRESENT, SYSTEM RESET ABORTED.

Note: NAC trouble configuration must be avoided for general announcement and must be limited to specific applications like notifying security person.

3.1.4 WALK TEST

WALK TEST is for testing the function of the system's initiating devices and signals by a person.

Press **WALK TEST** to configure **WALK TEST** feature. After the programming has completed, the system **TROUBLE** LED starts flashing indicating WALK TEST is ACTIVE.

3.1.5 UP and DOWN

Press the **UP** and **DOWN** keys to scroll through the system lists, such as the historical log and point database.

3.1.6 LEFT and RIGHT

Press the **LEFT** and **RIGHT** keys to scroll through screens with multiple options.

3.1.7 ESC

Press **ESC** to exit a menu or display and return to the top level structure.

The **ESC** key exits the menu structure one level at a time and returns the operator to the top level menu structure.

3.1.8 ENTER

Press **ENTER** to confirm your selection.

Press **ENTER** in the programming screen to confirm that the information on the display is correct.

3.2 LED indicators and piezo

Table 1: LED indicators

Component	LED color	Description
FIRE	Red	Indicates a fire alarm when flashing, an acknowledged alarm when steady on and no alarm when off.
CO/PRI2	Red	Indicates a priority 2 condition when flashing, an acknowledged condition when steady on and no CO/Pri-2 events when off.
SUPV	Yellow	Indicates a supervisory condition when flashing, an acknowledged condition when steady on and no Supervisory events when off.
TROUBLE	Yellow	Indicates a trouble condition when flashing, and an acknowledged trouble when steady on and no Trouble events when off.
GND FAULT	Yellow	Indicates an earth trouble when flashing and acknowledged trouble when steady on.
SILENCED	Yellow	Indicates NACs configured for alarm has been silenced when steady on.
DISABLED	Yellow	Indicates the system peripheral has been disabled when flashing, an acknowledged disabled condition when steady on and system peripherals are enabled when off.
AC POWER	Green	Indicates AC power is applied to the control unit when steady on and no AC power is applied when OFF

4 Operations

This section describes the alarm, supervisory and trouble conditions.

4.1 Alarm conditions (Fire or CO/PRI2)

An alarm condition occurs when an initiating device such as a manual pull station, smoke, or heat detector activates. The control unit indicates the presence of the alarm condition by:

- Displaying messages on the user interface
- Flashing the Fire Zone, if a pull station detector is assigned in zone 1 to zone 8, or **CO/PRI2** LED
- Activating the building's notification appliances such as horns and strobes

4.1.1 Recognizing an alarm condition

When an alarm condition occurs, the following events occur at the user interface:

- Fire:
 - The **FIRE** LED begins to blink.
 - The piezo begins to sound a pulsating tone.
 - The LCD screen shows the **Fire Alarm** screen, that shows the list of all the triggered alarms, as shown in [Figure 2](#).
- PRI2:
 - The **CO/PRI2** LED begins to blink.
 - The piezo begins to sound a pulsating tone.
 - The LCD screen shows the **CO/PRI-2 Alarm** screen, that shows the list of all the triggered alarms.

Note: A zone groups multiple points together, and the Zone Fire and Zone PRI2 Alarms lists display all the zones where alarm conditions occurred. Press **1** to view the points that triggered the alarms in each zone.

Press **ACK** to silence the piezo on the user interface. The LED stays ON.

4.1.1.1 Alarm screen

Figure 2: Alarm screen

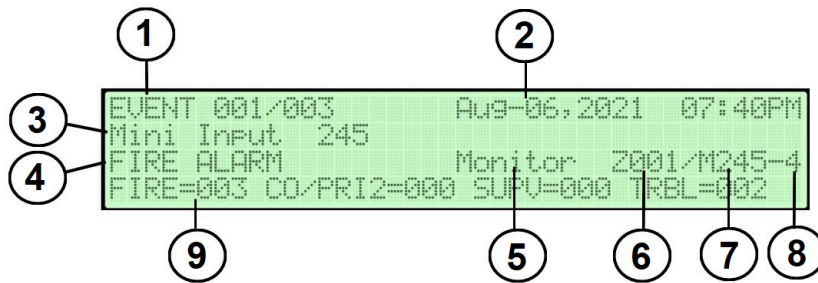

Callout	Description
1	Current alarm event index/Total alarm events present
2	Date-time of alarm event
3	Device label
4	Alarm event type
5	Device type
6	Zone ID
7	Device (D=Detector, M=Module) ID
8	Sub event type
9	Events counters

For information about the keys to use in the Alarm screen, see the following table.

Table 2: Keys in use in alarm by zone mode

Key Press	Action
1	To jump to the zone status visualization screen, only the zone in Alarm, Trouble, Supervisory, CO/PRI2 and Test will be displayed.
2	To jump to the loop device status visualization screen.
UP	To display the previously available point in alarm. To rollover from first to last alarm event.
DOWN	To display the next available point in alarm. To rollover from last to first alarm event.
ESC	Moves the UI to the summary screen.

4.2 Processing alarms

You can perform three actions when an alarm condition occurs:

- Acknowledge an alarm
- Silence the alarm
- Reset the system

This section explains each action in detail.

4.2.1 Acknowledging an alarm

Press **ACK** to acknowledge all the zones inside the **Zone Alarm** list.

Note: Acknowledging an alarm does not silence the horns. To silence an alarm, see [Silencing an alarm](#).

4.2.2 Silencing an alarm

Silencing an alarm turns off all the audible notification appliances that are programmed to turn off when it is pressed. Press **SILENCE** to silence the notification devices.

WARNING: Ensure the evacuation of the building is completed before silencing the alarm.

4.2.3 Resetting the system

After alarm activation, resetting the system returns it to a normal state. Press **RESET** to reset the alarms.

Important: Reset the system only after the source of the alarm is determined and dealt with.

Note:

- If a zone or device has reset successfully, the user interface returns to its normal display.
- If a zone or device remains in alarm when you reset the system, the system reset aborts. A message confirming the abort appears on the LCD screen.

4.3 Viewing the alarm condition details

Each alarm condition contains detailed information about the point or points that have triggered it.

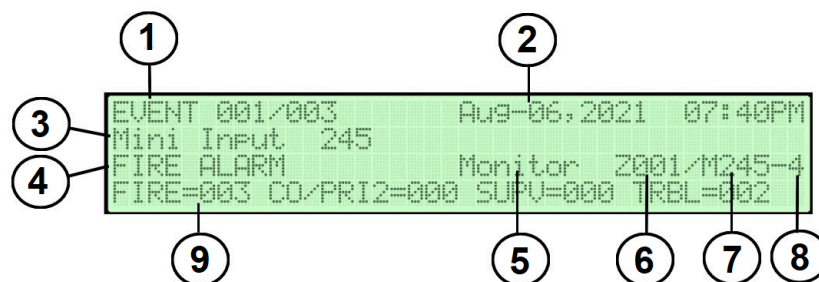
Figure 3: Alarm condition details

Callout	Description
1	Current alarm event index/total alarm events present
2	Date-time of event
3	Device label

Callout	Description
4	Event type
5	Device type
6	Zone ID
7	Device (D=Detector, M=Module) ID
8	Sub event type
9	Events counts

- To display **all zone status** visualization screen, press **1**. The LCD screen shows the following.

Figure 4: Overview of the zones in alarm

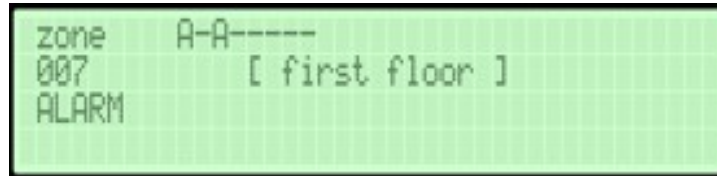

- To display **activated loop device status** visualization screen, press **2**. The LCD screen shows the following.

Figure 5: Activated loop device status

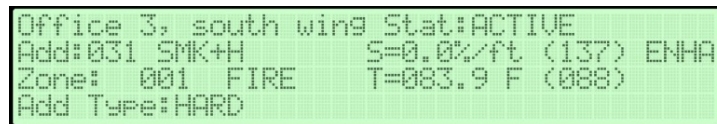

Note:

- Use **UP** or **DOWN** keys to display the information for the previous / next event.
 - After the expected event is displayed, press **2** to force the UI to jump to the **Detector status** screen (if the event is related to a point).
 - Press **1** you can jump to the **All zones status** screen. **ESC** to return.
- The CO/PRI2 is the same as the **Alarm** screen, the only difference is on the third row of the display as shown in [Figure 6](#).

Figure 6: Control unit status countdown

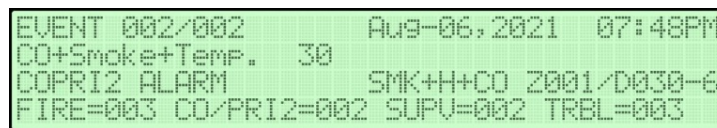

4.4 Supervisory and trouble conditions

A supervisory condition indicates a problem with the building's automatic sprinkler system or some other system used for the protection of life and property.

A trouble condition indicates the presence of a circuit break, or a ground, in a system point, or somewhere between the FACU and one of its points. You can use a trouble condition to indicate a failure in the system that requires attention.

The control unit indicates the presence of a supervisory or trouble condition by the following:

- Displaying messages on the user interface
- Flashing the **SUPV** or **TROUBLE** LEDs

4.4.1 Recognizing a supervisory and a trouble condition

When a supervisory event occurs, the following events occur at the user interface:

- The **SUPV** LED begins to blink
- The piezo sounds a Supervisory tone
- The LCD screen shows the **Summary** screen. After pressing **ACK, Supervisory** appears on the LCD screen (if Alarm/CO/PRI2 events not present in panel), that shows the list of all the Supervisory condition. Pressing **ACK** also silences the piezo. The LED stays on.

When a trouble event occurs, the following events occur at the user interface:

- The **TROUBLE** LED begins to blink

- The piezo sounds a Trouble tone
- The LCD screen shows the Summary screen. After pressing **ACK**, **Trouble** appears on the LCD screen (if Alarm / CO/PRI2 or Supervisory events are not present in the panel), that shows the list of all Troubles. Pressing **ACK** silences the piezo. The LED stays on.

4.4.2 Processing supervisory and trouble conditions

When a supervisory or a trouble event occurs, you need to acknowledge the event and resolve the cause of the event for the system to return to normal.

Press **ACK** to acknowledge a supervisory or trouble condition. All the zones inside the zone supervisory or trouble lists are acknowledged.

Note: A zone groups multiple points together and the Zone Supervisory or Zone Trouble list displays all the zones where Trouble or Supervisory conditions occurred.

4.4.3 Viewing the supervisory and trouble conditions details

Each supervisory or trouble condition contains detailed information about the point or points that have triggered it. To access that information, see [Figure 7](#).

Figure 7: Trouble menu details

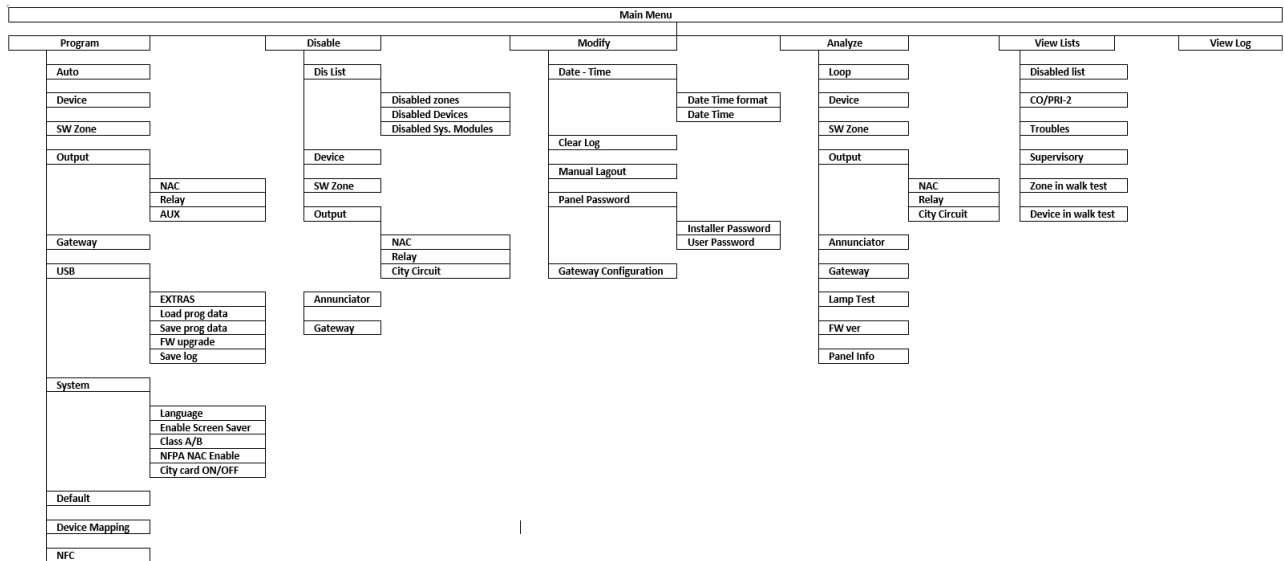

5 Using the control unit's interface

This section provides an overview of the user interface programming (main panel) of the control unit. Use the alphanumeric keypad, the cursor keys, the **ESC**, and the **ENTER** keys to manage the system from the user interface (main panel).

The information on the LCD screen is organized as screens that include the following:

- Start-up screen
- Screensaver screen
- MAIN screen
- Diagnostic screens
- Menu screen
- Events driven screen

5.1 Alphanumeric keypad

Use the alphanumeric keypad to create labels and enter data and codes. The alphanumeric string cannot exceed 20 characters. When you press an alphanumeric key in the position shown in [Table 3](#), as indicated by the cursor, the characters printed on the key appear in sequence and cyclically.

Table 3: Alphanumeric keypad functions

Key	Sequence
1	ABC1
2	DEF2
3	GHI3
4	JKL4
5	MNO5
6	PQR6
7	STU7
8	VWX8
9	YZ Blank 9
0	Blank 0

Note: Press **0** for more than one second to clear the entered data and return the cursor to its starting point.

5.2 Cursor keys

The following table describes the functionality of the control unit's cursor keys.

Table 4: Cursor keys function

Key	Function
UP	Use to scroll across the lines
DOWN	Use to scroll across the lines
RIGHT	Use to scroll along the line
LEFT	Use to scroll along the line

5.3 ESC and ENTER keys

The following table describes the functionality of the **ESC** and **ENTER** keys.

Table 5: ESC and ENTER keys function

Key	Function
ESC	Use to cancel the operation and return to the previous screen
ENTER	Use to confirm the operation performed

5.4 HELP key

This section describes the functionality of the **HELP** key. To explain the information on the LCD screen in the different screens, an embedded help feature is present on the control unit's LCD.

Table 6: HELP key functions for the main screen

Key	Help functions
ENTER	No function
ESC	Exits from the HELP to MAIN screen, or EVENT DRIVEN screen, if any press the key for more than 3 seconds to force the control unit to level 1.
UP and DOWN	Scrolls through the HELP list.
RIGHT and LEFT	No function

5.5 Buzzer or audible signals

The control unit buzzer provides an audible indication of the control unit's status. [Table 7](#) describes each buzzer signal.

Table 7: Buzzer patterns

Condition	Frequency (Hz)	Ton (s)	Toff (s)
SYSTEM TROUBLE (main processor failure)	1300	2.5	2.8
SYSTEM TROUBLE (Programming data corrupted)	660	1	1
ALARM	3300	0.2	0.2
CO/PRI2	880	0.5	0.5
TROUBLE	660	1	1
SUPERVISORY	440	2	2

Note: When an alarm status is silenced and a new fault signal is detected, the control unit restarts the buzzer with the previous alarm signal. To test the buzzer press **LAMP TEST**. The buzzer cannot work when you press **SILENCE BUZZER**.

5.6 Assistant text composition

To simplify the entry of text strings, an assisted procedure is included, based on a pre-compiled list of 128 vocabulary words with a maximum of 18 characters. When you press one of the numeric keys to enter a letter, the system inserts the first word in the list that begins with that letter.

The **UP** and **DOWN** keys load the next or the previous word in the list.

Press **UP** for more than three seconds to activate the assisted entry procedure.

Press **DOWN** for more than three seconds to deactivate the assisted entry procedure.

Figure 8: Assisted entry procedure

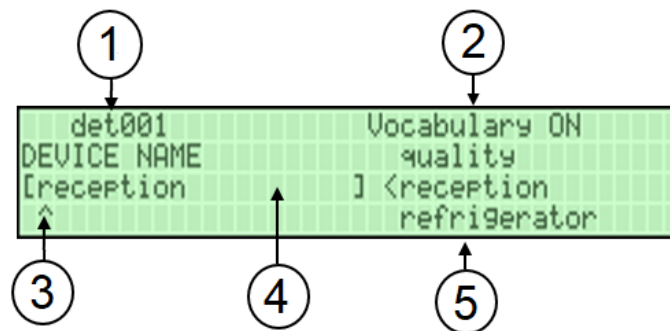

Callout	Description
1	Device coordinate
2	Assisted procedure active
3	Cursor
4	Entry area
5	Vocabulary area

When the assisted entry procedure is active, the string vocabulary **ON** blinks on the upper right area of the LCD screen. In the **Vocabulary** area the word currently selected, in the row aligned with the **Entry** area, is displayed. The word that precedes it in the vocabulary is displayed in the upper row while the next word is displayed in the lower row. In the **Entry** area the words used to compose the label are displayed.

To enter a word, press the numeric key, more than one time if necessary, related to the first letter of the word that needs to be entered. If this word is not correct, use the **UP** and **DOWN** keys to scroll through the vocabulary until a suitable word is found. During the vocabulary scan, the word in the middle row is entered in the **Entry** area at the cursor position. Use the **LEFT** and **RIGHT** keys to move the cursor to the beginning of each word.

5.6.1 Single selection

Use single selection to select a single value between a set of possible values. The maximum number of values is 8.

ON off

The selected value is displayed in upper case. The selection of a new value will automatically deselect the previously selected value. In this phase the keypad and keys have the following functions:

5.6.1.1 Alphanumeric keypad

No function is related to the alphanumeric keypad.

5.6.1.2 Cursor keys

Table 8 describes the functionality of the control unit's cursor keys.

Table 8: Cursor keys and function

Key	Function
UP	No function
DOWN	No function
RIGHT	Use to move the cursor to the next value position and select the value pointed to.
LEFT	Use to move the cursor to the previous value position and select the value pointed to.

5.6.1.3 ESC and ENTER keys

Table 9 describes the functionality of the **ESC** and **ENTER** keys.

Table 9: ESC and ENTER keys and description

Key	Function
ESC	Use to cancel the operation and return to the previous screen
ENTER	Use to accept the programmed parameter. The user interface moves to the next programming parameter screen, if any, or the user can press ESC to return to MAIN screen.

5.6.2 Startup sequence

When you access the control unit for the first time after installation, the user has to configure initial settings:

- Select the required language
- Verify the control unit type: A050 or A250. It is a read only parameter and is displayed based on the board assembly.
- Configure Installer password and User password

5.6.2.1 Configuring the initial settings

To configure the initial settings, complete one of the following:

- Press **1=ENG** to set English as the control unit's language.
- Press **2=ESP** to set Spanish as the control unit's language.
- Press **3=POR** to set Portuguese as the control unit's language.

5.6.2.2 Setting the control unit password

Figure 9 displays the correct version of the Addressable Panel Programmer to be used with the control unit.

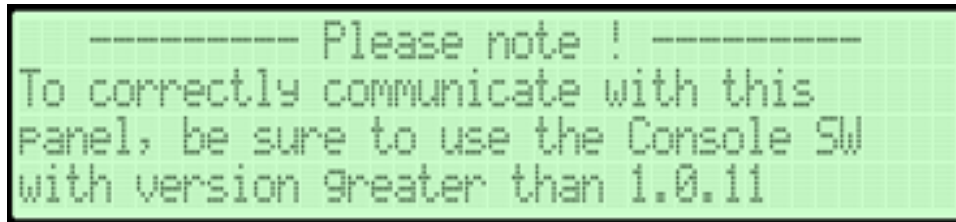
Figure 9: Software compatibility message

To change the control unit password for level 3 access and create a user password for level 1 access, complete the following steps:

1. Press **ENTER** to access the **Insert the Password []** screen.
2. Insert the default password 0000 and press **ENTER**.
If unsuccessful the LCD screen shows the following, **WRONG PASSWORD**. After a five second timeout the control unit returns to **Insert the Password []**.
3. Insert new **Create installer Password []**.
4. Re-enter the installer password to confirm. **Confirm Password []**.
If unsuccessful the LCD screen shows the following, **Password mismatch. Try again.** After a five second timeout the control unit returns to **Create user Password []**.
5. If successful, the LCD screen shows the following, **Create user Password []**.
6. Re-enter the user password to confirm **Confirm Password []**.
After confirming the password the LCD screen shows the start up screen.

Note:

- During the start-up screen, the control unit is not fully operative and the controls keys are not working.
- These screens are displayed only the first time a control unit is powered on.
- Each entered digit of password is masked with an asterisk symbol.

5.6.3 Screensaver screen

The screensaver screen contains an advertisement message set by the installer. The front screen is normally displayed when the control unit is in stand-by status and if the control unit is instructed to show it. The screen content and the enablement to display it are set by the APP SW. This screen can also be enabled or disabled from the control unit.

The screen saver should be in disabled mode after the panel is set to default.

The LCD screen shows:

Customize this screen using AUTOCALL CONSOLE software.

This screen is overridden by the Event driven screens and temporarily for 30 s by the **MAIN** screen when the control unit changes activity.

Note: Use APP software to modify this screen's content.

5.6.3.1 System normal

- You can enable or disable the screen saver from the control unit.
- If the screen saver is disabled and the system is in standby mode or event free, then the FACU shows **System Normal** on the LCD.
- The MAIN screen is overridden by the **System normal** screen after approx. 60 seconds.

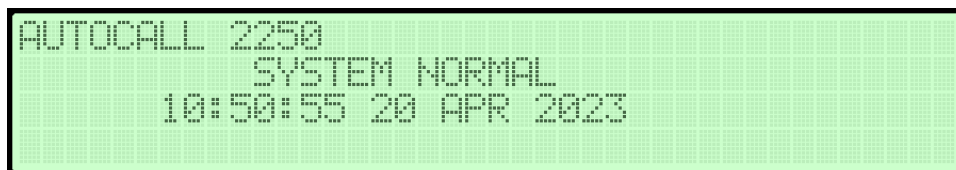
Figure 10: System normal

5.7 Main menu

The **MAIN** menu displays the functions available at the control unit. To access these functions use the following keys:

- Press the **UP** and **DOWN** keys to navigate between the options.
- Press **4** to go to the next options.

Table 10: MAIN menu information

MAIN menu icons	Description	Section
Program	Use the Program function to configure the control unit, component parameter.	Program menu: programming from the control unit
Disable	Use the Disable function to disable the various peripherals connected to the control unit.	Disable menu
Modify	The MODIFY screen contains the list of alarms that the control unit has received.	Modify menu
Analyze	The ANALYZE screen contains the list of Troubles that the control unit has received.	Analyze
View List	Use the View List screen to look for any configured point on the system controlled by the control unit.	View list
View Log	Tap the View Log button to reset all devices in alarm and clear all acknowledged Alarms, Troubles and Supervisory conditions.	Viewing the log

5.8 MAIN screen

After the start up sequence, the MAIN screen is the first screen displayed. The control unit is not configured for the loop devices or network devices so the LCD screen shows a **NOT CONFIGURED** message.

Figure 11: MAIN screen

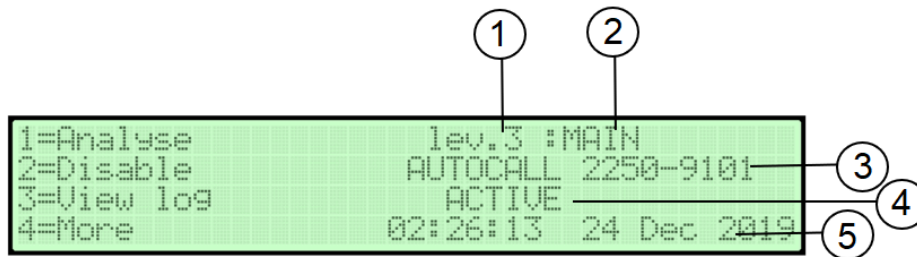

Callouts	Description
1	Access level
2	Control unit mode
3	Control unit name
4	Control unit activity
5	Control unit date and time

5.8.1 Access level

The **Access level** field shows the current access level of the control unit.

5.8.2 Control unit mode

The **Control unit mode** field displays the current mode of the control unit. The modes are as follows:

- **MAIN** - the control unit is active, its normal state.
- **ANALYSE**- the control unit is in analyzing mode.
- **PROGRAM**- the control unit is in programming mode.
- **MODIFY**- the control unit is in modifying mode.
- **DISABLE**- the control unit is in disabling mode
- **VIEW LISTS**- the control unit is displaying lists.
- **VIEW LOG**- the control unit is displaying historical logs.

5.8.3 Control unit name

The **Control unit name** field displays the control unit's current label.

The default label is AUTOCALL A050-9101 or AUTOCALL A250-9101.

The user can modify the control unit's label.

5.8.4 Control unit activity

The **Control unit activity** field displays the current activity of the control unit. [Table 11](#) lists the possible values for the control unit activity.

Table 11: Control unit activity information

Current control unit activity	Description
RESETTING	The control unit is resetting
INITIALIZING	The control unit is initializing
SYS. VER	The control unit is verifying itself
CLEAR LOG	The control unit is clearing log
ACTIVE	The control unit is active, its normal state
-----	No activity
NOT CONFIGURED	The control unit's state is not configured (it does not have a device database).

5.8.5 Control unit date and time

After a power cycle, if you do not update the **Date and Time** field, the **TROUBLE** LED turns on, the control unit logs the event in memory and communicates the event to the central station through the gateway.

6 User access level

Use a five digit unique password to log in to the control unit. Use the numeric keypad and the **ENTER** key to enter the unique password. At each login of any user or installer, the control unit logs the login event and the user or installer's ID. The control unit also logs the return to access level 1 to indicate the end of the user or installer's session.

Note: You can use four access levels to log in to the control unit, with the lowest, user access level 1, being the default access level. The access level chart lists the available functions that the user can access, as shown in the following table.

Table 12: Access level chart

MAIN menu	Sub menu	Sub-sub-menu	Level 3	Level 2	User Level 1	
Program	1 - Auto		*	*		
	2 - Device		*	*		
	3 - SW Zone		*	*		
	4 - Output		1 - NAC	*	*	
			2 - Relay	*	*	
			3 - AUX	*	*	
	5 - Gateway		*	*		
	6 - USB		0 - Extras	*	*	
			1 - Load prog data	*		
			2 - Save prog data	*	*	
			3 - FW upgrade	*		
			4 - Save log	*	*	
	7 - System		1 - Language	*	*	
			2 - Enable Screen Saver	*	*	
			3 - Wiring Class	*	*	
4 - NFPA NAC enable / disable			*	*		
5 - City card ON/OFF			*	*		
8 - Default		*				
9 - Device mapping		*	*			
0 - NFC		*	*			
Disable	1 - Dis List	1 - Disabled Zones	*	*		
		2 - Disabled devices	*	*		
		3 - Disabled system modules	*	*		
	2 - Device		*	*		
	3 - SW zone		*	*		
	4 - Output		1 - NAC	*	*	
			2 - Relay	*	*	
3 - City circuit			*	*		
5 - Annunciator		*	*			
6 - Gateway		*	*			
Modify	1 - Date and time		*	*		
	2 - Clear LOG		*			
	3 - Password		*			
	4 - Manual logout		*			
	5 - Gateway Config Yes / No		*	*		

Table 12: Access level chart

MAIN menu	Sub menu	Sub-sub-menu	Level 3	Level 2	User Level 1	
Analyze	1 - Loop		*	*	*	
	2 - Device		*	*	*	
	3 - SW zone		*	*	*	
	4 - Output	1 - NAC		*	*	*
		2 - Relay		*	*	*
		3 - City circuit		*	*	*
	5 - Annunciator		*	*	*	
	6 - Gateway		*	*	*	
	7 - Lamp test		*	*	*	
8 - FW version		*	*	*		
9 - Panel info		*	*	*		
View lists	1 - Disabled list		*	*	*	
	2 - CO/PRI-2		*	*	*	
	3 - Trouble		*	*	*	
	4 - Supervisory		*	*	*	
	5 - Zone in walk test		*	*	*	
	6 - Device in walk test		*	*	*	
View log			*	*	*	

Logout: After eight hours timeout, the control unit returns to the default access level 1. Otherwise the user or installer can select Manual Logout to exit level 2 or 3.

7 Program menu: programming from the control unit

Use the **PROGRAM** menu to configure different parameters of the control unit. The menu option is accessible to level 2 and 3. Use the **ESC** and **ENTER** keys to manage the system user interface.

Figure 12: PROGRAM menu

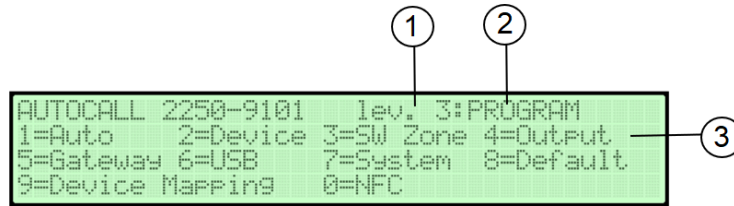

Callout	Description
1	Access level
2	Current status
3	Options

Table 13 describes the functionality of the control unit's keys.

Table 13: Keys function in PROGRAM menu

Key	Function
Numeric keys 0 to 9	Selects the option
Cursor keys	No function
ESC	Cancels the operation. Returns to the previous screen.
ENTER	No function

7.1 Auto

In the **PROGRAM** menu, use the **Auto** option to enroll the loop and RS485 network devices automatically (annunciator).

Press **1** to select a specific option based on the devices connected to the loop.

The **Auto** option consists of three main phases:

- Auto enrolling
- Auto addressing
- Device mapping

7.1.1 Loop break verification

If an open circuit is detected when enrolling is launched, the installer is prompted to launch the procedure to locate the loop break. The number of devices visible on the left and right side of the loop is calculated and displayed on the LCD. See the [Troubleshooting screens](#) section.

7.1.2 Double address checking

If a double address trouble is detected when enrolling is launched, the installer is prompted to switch on the LEDs of the involved devices.

7.1.3 Automatic zones assignment

After few seconds: the control unit prompts to choose the type of automatic zones assignment. During the enroll process, the control unit proposes to the installer, the three possible schemes used to assign the zones:

1. On loop basis
2. On device address basis
3. No assignment

7.1.4 Scheme 1

All the devices located on loop 1 are assigned to zone 1.

7.1.5 Scheme 2

- From address 01 to address 10 are assigned to zone 1.
- From address 11 to address 20 are assigned to zone 2.
- From address 21 to address 30 are assigned to zone 3.
- From address 31 to address 40 are assigned to zone 4.
- From address 41 to address 50 are assigned to zone 5.
- From address 51 to address 60 are assigned to zone 6.

7.1.6 Scheme 3

All the devices found on the loop are assigned to zone #0 (System zone).

7.1.7 Auto addressing flow

When enrolling has completed the following states occur:

- If there are any devices present on the loop that are not addressed, the LCD screen shows the number of not addressed devices found.
- The system initiates the auto addressing process and assigns all the non-addressed devices with addresses from 1 to 250. The address assignment is not sequential, because the address assignment is based on the unique serial number of the device or ancillary.
- The **Result** screen is displayed on the LCD screen when all the devices are addressed.

Note:

- The enroll process does not take place until all loop wiring troubles are removed.
- When there are NG1 devices on the loop, the auto-addressing procedure must be used, otherwise it does not have effect.
- The device mapping process does not take place until all double address troubles are removed.
- Ensure that there are only 250 devices present on the loop, if you connect more than 250 devices on the loop the auto addressing process will fail.

7.2 Device

The **Device** option in the **PROGRAM** menu activates the screen for selecting and programming the devices on the loops.

Figure 13: Access level and selecting device address

```

    1 2
    AUTOCALL 2250-9101   lev.3 :PROGRAM
    Add.= > 018<      Add Type:SOFT
                        Type:SMK+H+CO
    d002 [d018]
    3
  
```

Figure 14: Selecting the device function, to remove or keep the device and the device name

```

    4  det004           lev.3:PROGRAM
      LED (skp=skip test)  AUTOCALL 2250-9101
      off on SKP
      ^

    5  det004           lev.3:PROGRAM
      ADD TYPE:HARD        AUTOCALL 2250-9101
      hard SKP
      ^

    6  det004           lev.3:PROGRAM
      REMOVE DEVICE?     AUTOCALL 2250-9101
      NO yes
      ^

    7  det004           lev.3:PROGRAM
      DEVICE NAME        AUTOCALL 2250-9101
      [Temperature 4    ]
  
```

Figure 15: Selecting the fire mode and point type

```

    8  det004           lev.3:PROGRAM
      TEMP. MODE        AUTOCALL 2250-9101
      ROR fh135 fh200
      ^

    9  det004           lev.3:PROGRAM
      TEMP. POINT TYPE  AUTOCALL 2250-9101
      HEAT SUPV lSUPV
      ^
  
```

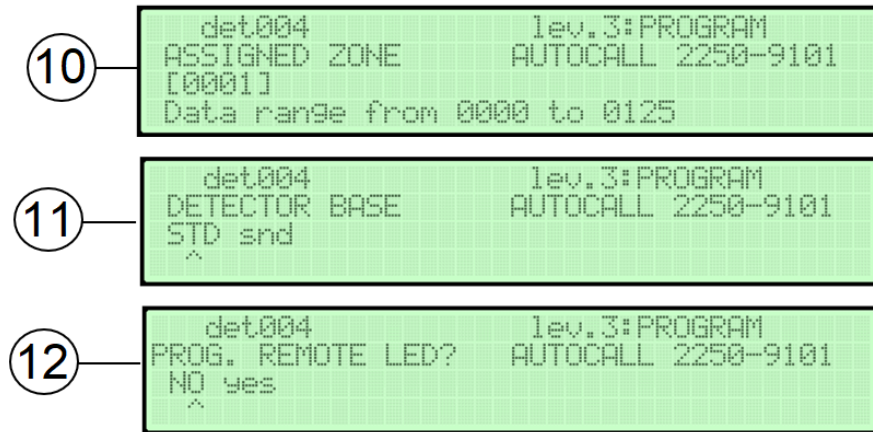
Figure 16: Selecting the zone number, detector base and the remote LED function

Callout	Description
1	Access level
2	Current status
3	Select device address
4	Select device LED function
5	Select remove or keep device
6	Select device name
7	Select fire mode
8	Select point type
9	Select zone number
10	Select detector base
11	Select remote LED function

The following table describes the functionality of the control unit's keys.

Table 14: Keys function in PROGRAM menu

Key	Function
Numeric keys 0 to 9	Selects the text.
LEFT and RIGHT keys	Navigation between the options.
ESC	Cancels the operation. Returns to the previous screen.
ENTER	Go to the Next screen.

See the following table for point types.

Table 15: Device point types

Device	Point Type	Functions
Photo / Heat Sensor	FIRE	Generic Fire Alarm Point
	SUPERV	Generic Supervisory Point
	LATSUPV	Latching Supervisory Point
Photo Sensor	SMOKE	Generic Fire Alarm Point
	SUPERV	Generic Supervisory Point
	DUCT	Fire Duct Detector
	SDUCT	Supervisory Duct Detector
Heat Sensor	LSDUCT	Latching Supervisory Duct Detector
	HEAT	Heat Detector
	SUPERV	Generic Supervisory Point
Triple Sensor	LATSUPV	Latching Supervisory Point
	FIRE	Generic Fire Alarm Point
	SUPERV	Generic Supervisory Point
	LATSUPV	Latching Supervisory Point
	GENPRI2	Priority 2 Alarm Point

7.3 Software (SW) zone

To select and program the software zones, complete the following steps:

1. In the **MAIN** menu, press **1** to select **Program**.
2. In the **PROGRAM** menu, press **3** to select **SW Zone**.
3. The LCD screen shows the **enter the SW zone number**.
4. Enter a valid zone number (1 to 50 for A050-9101 and 1 to 125 for A250-9101) and press **ENTER**.
5. Walk test enablement for the zone. If any option is selected other than OFF, the panel will ask for NAC trigger option.
6. ALARM VERIFICATION enablement for the zone.

7.4 Outputs

7.4.1 NAC configuration

In NAC configuration you can configure the NAC outputs. After selecting the NAC output, you can program the following parameters:

- NAC name
- Function type
- Coding pattern
- Zone assignment
- Device assignment
- Wiring class
- EOL resistor

7.4.1.1 NAC name

The output name can be defined (max. 20 characters).

7.4.1.2 Function type

Table 16: NAC function types

Function type	Description
SSIG	General alarm (on-until-silence). Use for NAC circuits containing only audible devices. If you use NAC circuits to connect external sync modules, set coding pattern as Steady .
RSIG	General alarm (on steady-until-reset). If you use NAC circuits to connect visual-only devices, set coding pattern as Sync . If you use NAC circuits to connect external sync modules, set coding pattern as Steady .
TROUBLE	NAC activates when there is a trouble condition active in the system. NAC is on until trouble condition is cleared or acknowledged.
SUPV	NAC activates when there is a supervisory condition active in the system. NAC is on until supervisory condition is cleared.
QALERT	General alarm horn and strobe (horn on-until-silence; strobe on-until-reset). Use for NAC circuits containing both horns and strobes. Note: If NFPA NAC is enabled, then the horns and strobes turn off, on when the SILENCE key is pressed.

7.4.1.3 Coding pattern

The following coding patterns are supported:

- TEMPORAL3: A three pulse coding pattern consisting of three 1/2 second pulses, each separated by 1/2 second silence. Each group of three pulses is separated by 1.5 seconds of silence.
- SYNCH: Generates synchronization pulse for visual only NAC circuits.
- STEADY: Steady ON.
- 20BPM: Slow March Time - 20 beats every minute.
- 120BPM: Fast March Time - 120 beats every minute.
- TEMPORAL4: A four pulse coding pattern consisting of four 100 msec pulses, each separated by 1/2 second silence.

7.4.1.4 Zone assignment

For each NAC circuit you can assign a maximum of four zones.

7.4.1.5 Device assignment

For each NAC circuit you can assign a maximum of three device addresses

7.4.1.6 Wiring class

Use this option to configure NAC wiring Class A or Class B.

7.4.1.7 EOL resistor

In NAC configuration you can configure EOL resistor. If you select class A wiring, the default 10 k resistor is configured for NAC.

You can configure the following values for EOL:

- 10 k ohm
- 3.9 k ohm
- 4.7 k ohm
- 5.1 k ohm
- 5.6 k ohm
- 15 k ohm

7.4.2 Programming the NAC output

To program the NAC output, complete the following steps:

1. In the **MAIN** menu, press **1** to select **Program**.
2. In the **PROGRAM** menu, press **4** to select **Output**.
3. Press **1** to select **NAC**.
4. Press **1** to select **NAC 1** programming. For A250-9101 panel, 4 NACs are available for programming.
5. If the NAC is disabled, the LCD screen shows the **Enable it?** prompt. Press **ENTER** to enable the NAC.
6. Press **ENTER** to configure the NAC name.
7. Use the numeric keypad to configure the NAC function type. Press **ENTER** to select the existing function type.
8. Use the numeric keypad to configure the NAC coding pattern or press **ENTER** to select the existing coding pattern.
9. If user wants the NAC to activate for any event in the panel, User can select the NAC to be panel trigger.

Assigning a zone for the NAC output

The user can assign a maximum of four zones for the single NAC output:

- If the system assigns the NAC output to zone one, the LCD screen shows the **ASSIGNED ZONE 0001** screen.
- If the system assigns the NAC output to zone two, the LCD screen shows the **ASSIGNED ZONE 0002** screen.
- If the system assigns the NAC output to zone three, the LCD screen shows the **ASSIGNED ZONE 0003** screen.
- If the system assigns the NAC output to zone four, the LCD screen shows the **ASSIGNED ZONE 0004** screen.
- If the zone assigned for the NAC output is out of range, the control unit displays the **WRONG VALUE!** screen.

Assigning a device trigger point for the NAC output

The system assigns a device trigger point for the NAC output causing the following screen messages:

- If the system assigns the NAC output to trigger point one, the control unit displays the **TRIGGER POINT 0001** screen.
- If the system assigns the NAC output to trigger point two, the control unit displays the **TRIGGER POINT 0002** screen.
- If the system assigns the NAC output to trigger point three, the control unit displays the **TRIGGER POINT 0003** screen.
- If the device trigger point assigned for the NAC output is out of range, the control unit displays the **WRONG VALUE!** screen.

After trigger points are selected, configure the style of wiring that the NAC is connected to **1=CLASS A** or **2=CLASS B**. Based on wiring style, the user must also configure the corresponding EOL RESISTOR that is connected to the NAC.

7.4.3 Programming relay output

Use the relay configuration option to configure the outputs. After selecting the relay output, you can program the following parameters:

- Relay name
- Function type

Relay name: You can define the output name with a maximum of 20 characters.

Function type: The control unit supports the following function types:

- RRELAY
- SRELAY
- DHOLDER
- PRI2
- SUPV
- TROUBLE

To program the relay name and function type, complete the following steps:

1. In the **MAIN** menu, press **1** to select **Program**.
2. In the **PROGRAM** menu, press **4** to select **Output**.
3. Press **2** to select **Relay**.
4. Press **1** or **2** to select the Relay programming option.
5. If the relay is disabled, the LCD screen shows the following, **Enable it?**. Press **ENTER** to enable the relay output or press **ESC** to return to the previous screen.
6. Press **ENTER** to configure the relay name.
7. Use the numeric keypad to configure the relay function type or press **ENTER** to select the existing function type.

7.4.4 Configuring auxiliary output

The control unit has two auxiliary power outputs. Both are configurable. Configure only one parameter for each auxiliary output. After selecting the auxiliary output that needs to be configured, you can configure the auxiliary power output as follows:

- Resettable or
- Non-resettable

Note: If auxiliary output is configured as non-resettable, in case of NAC/ MAIN overcurrent, the auxiliary output will be shut off momentarily for detection of over current source.

To configure the auxiliary outputs, complete the following steps:

1. In the **MAIN** menu, press **1** to select **Program**.
2. In the **PROGRAM** menu, press **4** to select **Output**.
3. Press **3** to select **AUX**.
4. Press **1** or **2** to select the Auxiliary Output.
5. Press **1** to select **Resettable** or press **2** to select **Non resettable**.

7.5 Configuring the gateway module

You can do basic Gateway configuration with the Panel UI, but for advanced options, use the Autocall Console tool. To configure the Gateway with the Autocall Console, refer to *2050 and 2250 Foundation Series Fire Alarm Control Units PC Programmer Installation Guide and Programming Instructions (579-1421AC)*.

Configuring Gateway using Panel UI

The Gateway option of the **PROGRAM** menu activates the procedure to configure the gateway module's:

1. Press the **ESC** key to go to **PROGRAM** control menu and press **1** to enter the **PROGRAM** menu.
2. To select **Gateway** press **5** for gateway settings.
3. By default, the Gateway is OFF. Select **1= ON** and press **ENTER** to turn ON the Gateway.

Figure 17: PROGRAM menu

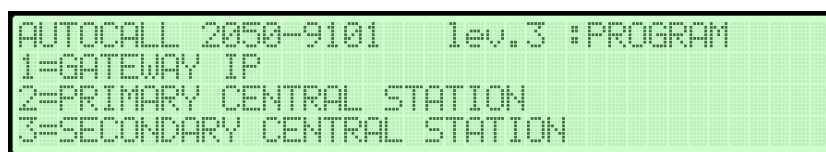

4. Select **1=GATEWAY IP** to program the IP address of the Gateway module. See [Configuring the gateway IP settings](#)

5. Select **2=PRIMARY CENTRAL STATION** to select the communication medium of primary station. See [Configure Central Station Receiver \(Primary and Secondary Central Station\)](#)
6. Select **3= SECONDARY CENTRAL STATION** to select the communication medium of Secondary station. See [Secondary central station](#)

Note: Change DNIS settings from the gateway's local web. Refer to *Gateway manual: A050 / A250 Panels IP Communicator /Connected Services Gateway Module Installation Guide (579-1463AC)*.

7.5.1 Configuring the gateway IP settings

You can configure the Gateway's IP settings for static IP address or dynamic IP address settings.

7.5.1.1 Configuring the STATIC IP Address:

1. In the **PROGRAM** menu, select Gateway Option, then select Gateway IP option select **1=STATIC** for static IP settings.
2. Configure the **STATIC IP ADDRESS** and press **ENTER**.

Figure 18: PROGRAM static IP address

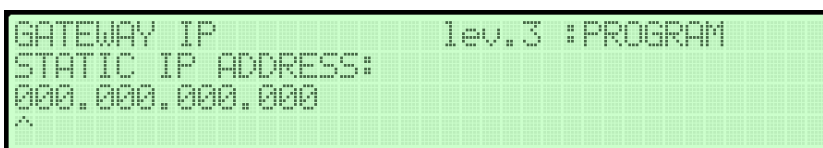

3. Configure the **STATIC SUBNET ADDRESS** and press **ENTER**.
4. Configure the **STATIC DEFAULT GATEWAY** and press **ENTER**.
5. Configure the **STATIC PRIMARY DNS** and press **ENTER**.
6. Configure the **STATIC SECONDARY DNS** and press **ENTER**.
7. To return to the GATEWAY PROGRAM screen, press **ENTER**.

7.5.1.2 Configuring the DYNAMIC IP Address:

1. In the **PROGRAM** menu, select Gateway Option.
2. Select **Gateway IP** option.
3. For dynamic IP settings, select **2=DHCP**.

7.5.2 Configure Central Station Receiver (Primary and Secondary Central Station)

You can configure the Primary Central Station and Secondary Central Station to use any of the paths to connect with the receiver. The path options are IP, PSTN or Cellular but only one option can be configured.

1. In the **PROGRAM** menu, select Gateway Option, then select **2= PRIMARY CENTRAL STATION** option.
2. Select **1=IP, 2=PSTN, or 3=CELLULAR**

7.5.2.1 If IP or Cellular option is selected configure as follows:

1. Use the numeric keys to enter the **IP ADDRESS**, then press **ENTER** (IP address of Central Station).
2. Use the numeric keys to enter the 4 digit **PSTN ACCOUNT NUMBER** then press **ENTER**.

Figure 19: PROGRAM PSTN account number

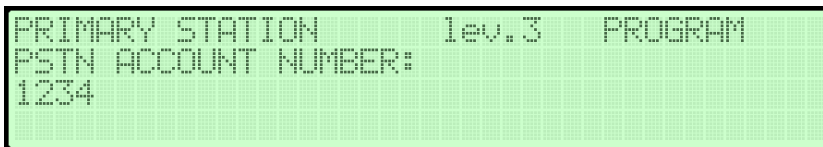

3. Use the numeric keys to enter the **IP SOURCE PORT** then press **ENTER** (You can set the source port number to any value between 0 and 99999, it must not be same as the destination port number).

Figure 20: PROGRAM IP source port

```

PRIMARY STATION      lev.3 PROGRAM
IP SOURCE PORT:
03050
    
```

4. Use the numeric keys to enter the **IP DESTINATION PORT** then press **ENTER** (Any value between 0 and 99999) to return to the GATEWAY PROGRAM screen.

Figure 21: PROGRAM IP destination port

```

PRIMARY STATION      lev.3 PROGRAM
IP DESTINATION PORT:
03061
    
```

Note: For configuration, get the DACR IP address and destination port number from Central Station management.

7.5.2.2 If PSTN option is selected configure as follows:

1. In the **PROGRAM** menu, Gateway Setting->1-ON-> press **2= PRIMARY CENTRAL STATION** or **3= SECONDARY CENTRAL STATION** -> **2=PSTN** then press **ENTER**.
2. Press **1** or **2** to select the PSTN line number then press **ENTER**.
3. Enter the 4 digit **PSTN ACCOUNT NUMBER** then press **ENTER**.
4. To return to GATEWAY PROGRAM screen, enter the **PSTN PHONE NUMBER** then press **ENTER**.

Figure 22: PROGRAM PSTN phone number

```

PRIMARY STATION      lev.3 PROGRAM
PSTN PHONE NUMBER:(17 DIGIT MAX)
00001234567890000
    
```

7.5.3 Secondary central station

Configure the Secondary Central Station receiver as follows:

1. In the **PROGRAM** menu, select Gateway Option -> **1=ON** -> **ENTER**, then select **3=SECONDARY CENTRAL STATION** option.
2. For the respective selected interface setting, see [Configure Central Station Receiver \(Primary and Secondary Central Station\)](#)
3. The user can also configure the Secondary Central station as a option **NONE**, this inactivates the secondary path.

7.5.4 Gateway configuration

In the panel, after you configure the gateway, to make it functional, update the configuration as follows:

1. Press **ESC** to get the Main Menu.
2. Select 3=Modify
3. Select 5=Gateway Config
4. Select 1=Yes

Note: Steps 1 to 4 takes approximately two minutes to configure the card. The panel displays **Hardware Reset in Progress**. After it completes, the panel restarts.

7.6 USB

The option **USB** in the **PROGRAMMING** menu activates the **USB programming** screen. Press **6** to select the **USB programming** screen. In the USB programming screen, you can select the following options :

0) Extras

1) Load programming

2) Save programming

3) FW upgrade

4) Save LOG

7.6.1 Loading programming data

To load the programming data from the USB pen drive to the control unit, complete the following steps:

1. In the **MAIN** menu, press **1** to select the **Program** option for programming the control unit. To return to the previous screen, press **ESC**.
2. In the **PROGRAM** menu, press **6** to select the **USB** option for USB activities. To return to the previous screen, press **ESC**. The program file must be present in the USB pen drive in folder name: F_PROG.
3. Press **1** to select the **Load Programming Data** option to load the programming data to the control unit.
4. Press **1** to select the **Load Console Data** option to load the console data.
5. If successful, the LCD screen shows the following, **Load PROGRAMMING data from USB pendrive DONE**. If unsuccessful, the LCD screen shows the following, **Load PROGRAMMING data from USB pendrive FAILED**.

7.6.2 Loading JSON data

To load the programming data from the USB pen drive to the control unit, complete the following steps:

1. In the **MAIN** menu, press **1** to select the **PROGRAM** option for programming the control unit. To return to the previous screen, press **ESC**.
2. In the **PROGRAM** menu, press **6** to select the **USB** option for USB activities. To return to the previous screen, press **ESC**.
3. Press **1** to select **Load Programming Data** option to load the console or JSON programming data to the control unit.
4. Press **2** to select the **Load JSON Data** option to load the console data. JSON data file with name as the panel's serial number must be present in the USB pen drive in folder name: F_JSON.
5. When the system restarts, the system starts processing **QR ADDRESSING IN PROGRESS**. When the addressing is complete, the LCD screen shows **QR ADDRESSING COMPLETED** and then **CONFIGURATION SUMMARY**.
For failures other than a connection issue or a file not present, the panel also shows on the LCD screen the reason for the failure.
If the panel type in the JSON file is different to the actual panel, the LCD screen shows **FAILED: PANEL TYPE ERROR**.
If the CRC mismatch during transmission **FAILED: CRC ERROR**.
If the brand type is different to the actual brand **FAILED: BRAND TYPE ERROR**.

7.6.3 Saving the programming data

To save the current programming data from the control unit to a USB pen drive, complete the following steps:

1. In the **MAIN** menu, press **1** to select the **Program** option for programming the control unit.
2. In the **PROGRAM** menu, press **6** to select the **USB** option for USB options. To return to the previous screen, press **ESC**.
3. Press **2** to select the **Save Programming Data** option to save current programming data to the control unit.
4. Press **1** to select **Save Console Data** option to save current programming data of the control unit.
5. If successful, the LCD screen shows the following, **Save PROGRAMMING data into USB pendrive DONE**. If unsuccessful, the LCD screen shows the following, **Save PROGRAMMING data into USB pendrive FAILED**.
6. Press **ESC** to return to the **Programming screen**.
7. If successful, the Programming file will be created in the USB pen drive in folder name: F_PROG

7.6.4 Saving the JSON data

To save the current JSON data from the control unit to a USB pen drive, complete the following steps:

1. In the **MAIN** menu, press **1** to select the **Program** option for programming the control unit.
2. In the **PROGRAM** menu, press **6** to select the **USB** option for USB options. To return to the previous screen, press **ESC**.
3. Press **2** to select **Save Programming Data**.
4. Press **2** to select **Save JSON Data** option to save current programming data of the control unit.
If successful, the LCD screen shows the following, **Save JSON data into USB pendrive DONE**. If unsuccessful, the LCD screen shows the following, **Save JSON data into USB pendrive FAILED**.

Press **ESC** to return to the **Programming screen**.

If successful, a JSON data file will be created in the USB pen drive in folder name: F_JSON.

7.6.5 Upgrading firmware

Use a USB pen drive to upgrade the control unit's firmware, by following these steps:

1. In the **MAIN** menu, press **1** to select the **Program** option for programming the control unit.
2. In the **PROGRAM** menu, press **6** to select the **USB** option for USB activities. To return to the previous screen, press **ESC**.
3. Press **3** to select **FW Upgrade**. The firmware binary file must be placed in folder name: F_FW
4. The control unit restarts after the firmware upgrade and the LCD screen shows the start up screen sequence.
Panel Suspended: FW upgrade IN PROGRESS
AUX CONTROLLER FIRMWARE UPDATE IN PROGRESS
5. After the FW update has completed, the LCD screen shows
FIRMWARE UPDATE COMPLETED PANEL WILL RESTART IN 5 SECONDS

7.6.6 Saving the log data

To save the control unit's current log data from the control unit to a USB pen drive, complete the following steps:

1. In the **MAIN** menu, press **1** to select the **Program** option for programming the control unit.
2. In the **PROGRAM** menu, press **6** to select the **USB** option for USB options. To return to the previous screen, press **ESC**.
3. Press **4** to select the **Save Log** option. To return to the previous screen, press **ESC**.
If successful, the LCD screen shows the following, **Save LOG into USB pendrive DONE**.
If unsuccessful, the LCD screen shows the following, **Save LOG into USB pendrive FAILED**.
4. If successful, a log file will be created in folder name: F_LOG

7.6.7 Loading help files

To load the help file from the USB pen drive to the control unit, complete the following steps:

1. In the **MAIN** menu, press **1** to select the **Program** option for programming the control unit. To return to the previous screen, press **ESC**.
2. In the **PROGRAM** menu, press **6** to select the **USB** option for USB activities. To return to the previous screen, press **ESC**. The program file must be present in the USB pen drive in folder name: F_LANG.
3. Press **0** to select the **Extras** option to load the help file to the control unit.
4. Press **1** to select the **Load Help files** option and then press **Enter** to load the help files.
5. If it is 100% completed then press **ESC**.

7.7 System

In the **PROGRAMMING** menu, the option **SYSTEM** activates the system language selection screen. **Display language:**

After selecting the language, you can program:

- Enable screensaver
- Class A or B wiring
- NFPA
- City Circuit Card

7.7.1 Language selection

The panel supports three languages. Spanish, English and Portuguese. Complete the following steps to select the language:

1. In the **MAIN** menu, press **1** to select the **Program** option for programming the control unit.
2. In the **PROGRAM** menu, Press **7** to select the **System** option. To return to the previous screen, press **ESC**.
3. The LCD screen shows the following, **System LANGUAGE**. Press **ENTER** to confirm the language selection. To return to the previous screen, press **ESC**.

7.7.2 Enable screensaver

When set as **YES**, the customizable front screen is displayed, otherwise it is permanently removed.

To enable the screen-saver, complete the following steps:

1. In the **MAIN** menu, press **1** to select the **Program** option for programming the control unit.
2. In the **PROGRAM** menu, press **7** to select the **System** option. To return to the previous screen, press **ESC**.
3. The **PROGRAM** menu displays **System LANGUAGE**. Press **ENTER** to confirm the language selection. To return to the previous screen, press **ESC**.
4. Press **ENTER** to enable the screensaver. To return to the previous screen, press **ESC**.

7.7.3 Wiring class selection

Wiring style for loop: Each loop may be individually set to work in 2 wires mode (multiple selection). When the 2 wires option is selected, you can connect devices on both the left and right sides of the loops (2 spurs). This allows for the connection of up to two spurs to the control unit.

To select the wiring class, complete the following steps:

1. In the **MAIN** menu, press **1** to select the Program option for programming the control unit.
2. In the **PROGRAM** menu, press **7** to select the System option. To return to the previous screen, press **ESC**.
3. The **PROGRAM** menu displays System LANGUAGE. Press **ENTER** to confirm the language selection. To return to the previous screen, press **ESC**.
4. Press **ENTER** to enable the screensaver. To return to the previous screen, press **ESC**.
5. Press **ENTER** to enable CLA or CLB WIRING CLASS. To return to the previous screen, press **ESC**.

7.7.4 Enabling NFPA

The user can enable the NFPA. By default NFPA is disabled. To enable the NFPA, complete the following steps:

1. In the **MAIN** menu, press **1** to select the **Program** option for programming the control unit.
2. In the **PROGRAM** menu, press **7** to select the **System** option. To return to the previous screen, press **ESC**.
3. The **PROGRAM** menu displays **System LANGUAGE**. Press **ENTER** to confirm the language selection. To return to the previous screen, press **ESC**.
4. Press **ENTER** to enable the screensaver. To return to the previous screen, press **ESC**.
5. Press **ENTER** to enable CLA or CLB WIRING CLASS. To return to the previous screen, press **ESC**.
6. Press **ENTER** to enable NFPA.

7.7.5 Enabling city card

The user can enable the City Card. By default the City card is disabled. To enable the City card, complete the following steps:

1. In the **MAIN** menu, press **1** to select the **Program** option for programming the control unit.
2. In the **PROGRAM** menu press **7** to select the **System** option. To return to the previous screen, press **ESC**.
3. The **PROGRAM** menu displays **System LANGUAGE** options. Press **ENTER** to confirm the language selection. To return to the previous screen, press **ESC**.
4. Press **ENTER** to enable the screensaver. To return to the previous screen, press **ESC**.
5. Press **ENTER** to enable CLA or CLB WIRING CLASS. To return to the previous screen, press **ESC**.
6. Press **ENTER** to enable NFPA.
7. Select yes and press **ENTER** to enable CITY CARD.

7.8 Default

To restore the default setting, complete the following steps:

1. In the **MAIN** menu, press **1** to select the **Program** option for programming the control unit.
2. In the **PROGRAM** menu, press **8** to select the **Default** option. To return to the previous screen, press **ESC**.
3. Press **ENTER** to continue.
The LCD screen shows the following, **WARNING DEFAULT data loading in progress The system will restart** while loading the default data. The system restarts after loading the default data and the start sequence is repeated.

7.9 Device mapping

This option activates the **On Demand Device Mapping** feature to modify the devices addressing scheme in a working system. In a system where the addressing scheme is well known because all devices are singularly addressed through the **Service Tool** or through the **Device Mapping** feature embedded in the loop enroll process (1 KEY). This means that this new feature is not intended to acquire new devices on the loops, use the **Enroll** feature for this purpose. In contrast to the **Device Mapping** feature embedded in the loop enroll process, the **On Demand** version does not automatically modify devices, labels and assigned zones.

Note: All the devices, including the unique types, will put in the activated list. Only the output type devices are treated as in the standard device mapping procedure. They will be singularly activated when selected in the list.

1. Press **1** to select the **Program** option for programming the control unit.
2. Press **9** to select the **Device Mapping** option. To return to the previous screen, press **ESC**.
The system initiates the device mapping sequence and the LCD screen shows **Gathering Information RUNNING Wait Please**.
The LCD screen shows the following, **Device Mapping** when the device mapping is running.
3. Press **ESC** to quit the running process.
4. Press **ESC** to return to the device mapping process.
5. Press **ENTER** to quit the device mapping process.
The system returns to the **MAIN** menu.

7.10 NFC

Using the NFC feature, the user can program the panel. For more details refer to *2050 & 2250 Foundation Series Fire Alarm Control Units PC Programmer Installation Guide* and *Programming Instructions 579-1421AC*.

8 Disable menu

Use the **DISABLE** menu to enable or disable different controls on the panel. The following options are available in the **DISABLE** menu: screen.

- List of disabled devices including input and output devices.
- Loop device
- SW zones
- Outputs of the control unit
- Annunciator
- Gateway

Note:

- When you disable any entity, the disabled trouble is generated and **TROUBLE** LED and **DISABLED** LED on the user interface start blinking.
- Any alarm or fault related to the disabled device is ignored.
- The output devices enabled during alarm or programmed fault status are activated immediately.

Table 17: Buttons

Key	Function
1	Selects the Disabled List
2	Selects the Loop devices option to enable or disable
3	Selects the SW zones option to enable or disable
4	Selects the Outputs option to enable or disable
5	Selects the Annunciator option to enable or disable
6	Selects the Gateway option to enable or disable
ESC	Cancels the operation. Returns to the previous screen.
ENTER	No function

To access the **DISABLE** menu, the user needs to log in to the control unit at access level 2 or 3.

The LCD screen shows the current mode. The mode **DISABLE** indicates that the control unit is in disablement mode.

The disabled and enabled values are as follows:

- **Input Devices:** A disabled input device such as a detector, input module, conventional zone module or addressable pull-stations, will not generate an alarm or trouble status.
- **Output Devices:** An alarm or trouble status will not activate disabled output peripherals.
 - When any device or module is disabled, the **DISABLED** LED and **TROUBLE** LED start flashing and it is added in the trouble logs. The disabled event is also logged in log events.

Note:

- Output devices enabled during ALARM or TROUBLE status (programmed), are activated immediately.
- If any option is already disabled and a high priority event is generated, then the event can be viewed in the **Disabled list** option in the **DISABLE** menu.

8.1 Disabled list

In the **DISABLE** menu press **1**. If any of the elements are disabled, the **DISABLED** LED and **TROUBLE** LED on the user interface illuminate. In the **Disabled list** menu, three options are used to select a list to analyze.

- Press **1** to view the list of **Disabled Zones**.
- Press **2** to select the **Disabled Devices** option and view the list of disabled loop devices.
- Press **3** to select the **Disabled Sys. Modules** and view the list of disabled system parts, such as NAC, relay, gateway, annunciator and city circuit.

The following table describes the functionality of the control unit's keys.

Table 18: Disabled list menu option keys and functions

Key	Function
1	Shows the list of disabled zones.
2	Shows the list of disabled loop devices.
3	Shows the list of disabled system parts, such as Outputs and Communicator.
Cursor keys	No function.

Table 18: Disabled list menu option keys and functions

Key	Function
ESC	Cancels the operation. Returns to the previous screen.
ENTER	No function.

8.1.1 Disabled zones

Press **1** to display the number of disabled zones.

8.1.2 Disabled devices

Press **2** to display the number of loop devices disabled.

8.1.3 Disabled system modules

Press **3** to display the number of disabled system parts, such as outputs, gateway and annunciators.

The following table describes the functionality of the control unit's keys.

Table 19: Disabled zones, loop devices and system parts keys and functions

Key	Function
1	Calls the enablement screen to enable the displayed part, such as the zone, device, system part.
UP	Selects the previous item
DOWN	Selects the next item
RIGHT and LEFT	No functions
ESC	Cancels the operation. Returns to the MAIN screen.
ENTER	No function

8.2 Device

To disable a device, press **2** and select **Device Disable**. If the device is in the system, square brackets are shown around the address. If the address does not exist or it is different from that selected in the underlying bar, the arrows are shown.

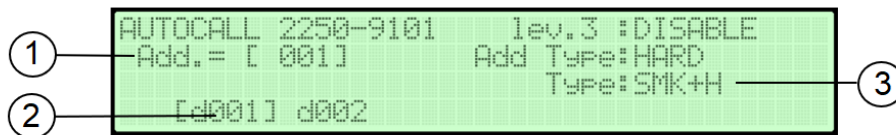
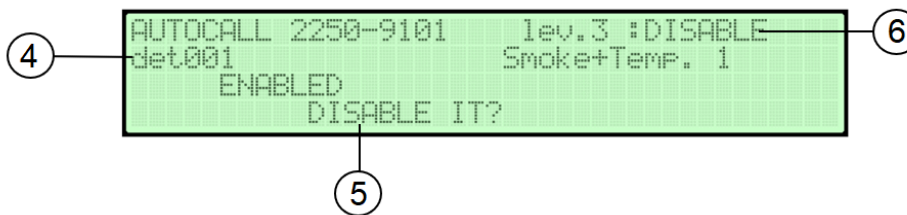
Figure 23: Disabled zones display

Figure 24: Disabled device display

Callout	Description
1	Type of selected device
2	List of current devices
3	Programming address
4	Device to enable or disable
5	Enable or disable request
6	Panel mode

Table 20 describes the functionality of the control unit's keys.

Table 20: Disabled loop devices menu keys and functions

Key	Function
UP and DOWN	No function
RIGHT	Selects the next device
LEFT	Selects the previous device
ESC	Cancels the operation. Returns to the previous screen.
ENTER	Confirms and the UI moves to the next screen.

8.3 SW zone

To disable the software zone use option 3 in the **DISABLE** menu. After the zone has been selected you can disable or enable it.

Enter the zone number and press **ENTER**, the LCD screen shows an **ENABLE** or **DISABLE** request for the zone.

If already **ENABLED**, pressing the **ENTER** key, causes the zone to be **DISABLED**.

The following table describes the functionality of the control unit's keys.

Table 21: Disabled SW zone display keys function

Key	Function
UP	No function
DOWN	No function
ESC	Cancels the operation. Returns to the previous screen
ENTER	Confirms and the UI moves to the next screen

8.4 Output

To disable an output, such as an NAC, relay or city circuit, press **4**. Use the **UP** and **DOWN** keys to select the output. To enable or disable the output, press **ENTER**.

If already **ENABLED**, pressing the **ENTER** key, causes the output to be disabled.

The following table describes the functionality of the control unit's keys.

Table 22: Disabled output menu keys and functions

Key	Function
UP	Selects the previous item
DOWN	Selects the next item.
ESC	Cancels the operation. Returns to the previous screen.
ENTER	Confirms and the UI moves to the next screen.

8.5 Annunciator

When you select the annunciator you can enable or disable it. Press **5** to select the **Annunciator** option from the **DISABLE** menu. Enter the Annunciator number and press **ENTER**,

The panel displays an **ENABLED** or **DISABLED** request for the Annunciator.

Press **ENTER**, to disable the Annunciator.

The following table describes the functionality of the control unit's keys.

Table 23: Keys function in the annunciator option

Key	Function
UP	No function
DOWN	No function
ESC	Cancels the operation Returns to the previous screen.
ENTER	Confirms and the UI moves to the next screen.

Note: If the annunciator ID is not present in control unit's configuration data, the LCD screen displays the following,

Wrong value, please enter the parameter again

8.6 Gateway

In the **DISABLE** menu, to disable a communications device, select the **Gateway** option . Press **6** to enable or disable the Gateway module.

Note: Gateway must be ON. If Gateway is off and you select **6 = gateway** option on the disabled menu, then the panel must display **GATEWAY IS OFF** message.

Press **6 = Gateway**, panel displays **ENABLED** or **DISABLED** request for Gateway.

Table 24: Key function in gateway option

Key	Function
UP	No function
DOWN	No function
ESC	Cancels the operation Returns to the previous screen.
ENTER	Confirms and the UI moves to the next screen.

9 Modify menu

In the **MAIN** menu, press **3** to access the **MODIFY** menu. Use the installer password or the user password to access the **MODIFY** menu.

Use the control unit's user password or installer password to access the following options:

- **1 = Date-Time**
- **4 = Manual Logout**
- **5 = Gateway config Yes / No**

Use the control unit's password to login into the control unit to access the following options:

- **2 - Clear LOG**
- **3 - Password**

The following table describes the functionality of the control unit's keys.

Table 25: Key function in the MODIFY menu

Key	Function
1	Updates time (hh:mm:ss) and date (dd:mm:yy)
2	Clears log
3	Modify the user and installer password
4	Logout from Access level 2 or 3
5	To send Gateway configuration
Cursor keys	No function
ESC	Cancels the operation Returns to the previous screen
ENTER	No function

9.1 Date and time

In the **MODIFY** menu, press **1** to select the **Date-Time** option to enter or change the control unit's date and time.

After you select the **1 = Date-Time format**, the LCD screen shows the **Date** and **Time** fields. You can use the number keys to modify the **Date** and **Time** fields. Press **ENTER** to validate the changes. To return to the **MAIN** menu, press **ESC**.

The following table describes the functionality of the control unit's keys.

Table 26: Key function in the date and time field menu

Key	Function
Numeric keys 0 - 9	Use these keys to edit the fields
Cursor keys	No function
ESC	Cancels the operation. Returns to the previous screen.
ENTER	Validates the changes and go to MAIN menu.

9.2 Clearing the log

When you log into the control unit, use the control unit password to access the **Clear LOG** option. This operation is logged into memory. The clear log event is the last event the user can see in the entire log. The installer continues to have access to the entire log.

To clear the log, complete the following steps:

1. In the **MODIFY** menu, press **2** to select the **Clear LOG** option.
2. Press **ENTER** to clear the log, confirming this action deletes all data.
3. The system clears the log and the LCD screen shows the following, **CLEAR LOG** string in the activity field.
4. When the system completes the **CLEAR LOG** operation, the control unit resets.

Table 27: Key function in the clear log menu

Key	Function
ESC	Cancels the operation. Returns to the previous screen
ENTER	Clear the log memory and resets the control unit

After CLEAR LOG operation has finished, it generates four events in the Log.

- a. INSTALLER ACCESS
- b. SERVICE MODE
- c. CLEAR LOG
- d. HARDWARE RESET

9.3 Modifying the control unit password

Press **3** to modify the user and installer password.

To modify the control unit's password, complete the following steps:

1. Select **1 = Installer password**, then enter the existing five-digit old installer password, when the LCD screen shows the following, **Insert the password**

Note: Installer password must start with digit 9, the next four digits can be any numeric value (0-9). User interface password must start with 1.

2. Enter the new installer password
3. Re-enter the same password for verification.

If the passwords match, the LCD screen shows the **Success!** message, and returns to the **MAIN** menu.

If the passwords do not match, the LCD screen shows the following, **Password mismatch. Try again.** message, before returning to the **Modify installer password** screen.

The following table describes the functionality of the control unit's keys.

Table 28: Key function in the modifying the password menu

Key	Function
Numeric keys 0 to 9	Use to enter password
Cursor keys	No function
ESC	Cancels the operation Returns to the previous screen
ENTER	Validates the changes and go to next screen

Follow the same steps for modifying the user password

9.4 Configuring the Gateway

1. Press **5** to reconfigure the gateway module.
When gateway configuration related changes are done from the panel or console, to set the config in the panel, gateway module needs to be reconfigured manually.
2. Press **5 = Gateway config**. The LCD screen shows the following, **GATEWAY CONFIG** options **1= Yes 2= No**
3. If **1 =Yes** is selected, gateway re-configuration starts, and the panel moves **MAIN** screen and will display '**Gateway configuring**' status. Once gateway configuration is done, the panel will perform HW reset, and configuration is set in the panel successfully.

Note: Events generated during gateway configuration state will not be reported to central station.

10 Analyze

In the **MAIN** menu, the user can view parameters by selecting **View parameters**. Press **1** for the **ANALYZE** option. For the **ANALYZE** menu. The following table describes the function of the control unit's keys.

Table 29: Key function of the ANALYZE menu

Key	Function
1	Loop: Starts the procedure to enable selection and viewing of loop data.
2	Device: Activates the selection and visualization sequence of real time loop device data.
3	SW zone: Activates the selection and display procedure for the data corresponding to all SW zones.
4	Output: Activates the selection and viewing procedure for the data corresponding to an output.
5	Annunciator: Starts the procedure to view all Annunciators status.
6	Gateway: Activates the viewing sequence for gateway status.
7	Lamp test: Users can test the control unit buzzer and LEDs.
8	FW version: start the procedure for viewing of FW version of all processors in the control unit.
9	Panel info: start the procedure for viewing control unit information.
Cursor keys	No function
ESC	<ul style="list-style-type: none"> • Cancels the operation • Returns to the previous screen
ENTER	No function

10.1 Loop

Press **1** to view the loop data. The **Loop =** field displays the loop details.

The **Detectors** field displays the number of detectors sensed on the relevant loop.

The **Modules** field displays the number of modules sensed on the relevant loop.

The **Status** field displays the status of the selected loop. The possible values are:

- Working: loop is in stand-by condition (normal operation)
- Trouble: there is some hardware loop related trouble (for example, loop signal open)

The **Loop** field displays in real time, (five seconds data refresh rate), the total current supplied to all loops. The LCD screen also shows the real time value of the loop current.

10.2 Device

1. Use **2** to view the loop devices. **Stat:** indicates the device status field and displays the current status of the detector or module. The following list contains the possible values for the device status field.
 - WORKING: device is in normal operation mode.
 - ACTIVE: device is in alarm condition
 - CO-PRI2: device is in CO/PRI2 condition.
 - SUPERVISORY: device is in supervisory condition.
 - TROUBLE: device is in trouble condition.
 - ZONE DISABLED: zone to which the device belongs is disabled.
 - DISABLED: device is disabled.
 - WALK TEST: device is activated in walk test condition.

Table 30: Key function in the device menu

Key	Function
UP and DOWN	No function
RIGHT	Selects the next available device
LEFT	Selects the previously available device
ESC	Cancels the operation. Returns to the previous screen.
ENTER	Confirms and displays the information for the selected device

Note:

- Use the Alphanumeric keypad to insert the device address. If the address does not exist, the system selects the next available device.
- If the device is in the system, square brackets are present near the address. If the address does not exist, or is different from that selected in the underlying bar, arrows are shown.

2. Select the device and press **ENTER**, device details are displayed.

10.3 Software zone

In the **ANALYZE** menu, press **3** to access the **SWZone** option. The **SWZone** option activates the viewing of the software zones. The A050 control unit supports a maximum of 50 software zones and the A250 control unit supports 125.

The LCD screen shows the status of each SW zone in compact format. The system uses the following list of abbreviations to indicate the status of the SW zones:

- **.** for **UNUSED** indicates a zone that is not in use and has no devices assigned to it.
- **A** for **ALARM** indicates a zone that is in **Alarm** mode.
- **C** for **CO/PRI2** indicates a zone in **CO/PRI2** mode.
- **S** for **SUPERVISORY** indicates a zone in **SUPERVISORY** mode.
- **T** for **TROUBLE** indicates a zone in **Trouble** mode.
- **X** for **DISABLED** indicates a disabled zone.
- **w** for **WALK TEST** indicates zone in **Test** mode.
- **W** for **WALK TEST ON** indicates that at least one point in the zone is active in **Test** mode.
- **_** for **ST-BY** indicates a zone in **Standby** mode.
- **D** for **DIRTY** indicates that at least one smoke detector in the zone is dirty.

Note: The LCD screen shows the zone status on two screens for the A250 control unit. It shows 1 to 25 zones at a time, for next zone status press **UP**.

10.4 Output

In the **ANALYZE** menu, press **4** to select the **Output** option . The **Output** option activates viewing of the outputs. The LCD screen shows the status of all the outputs, NAC, relay city circuit, in compact format.

10.4.1 NAC

In the **ANALYZE** output sub menu, press **1** to select the **NAC** option . Select the **NAC** option to view the following parameters:

- NAC name
- Function type
- Coding pattern
- Zone assigned
- Device assigned
- EOL resistor
- Status

The system uses the following list of abbreviations to indicate the status of the NAC:

- **DISABLED** indicates that an output is disabled.
- **ACTIVE** indicates an active output.
- **SHORTED** indicates a shorted output.
- **OPEN** indicates an open output.
- **STANDBY** indicates that an output is in supervisory.
- **OVERCURRENT** indicates that an output is in an overcurrent condition.

Select the option number for the relevant NAC and press **ENTER**, the NAC's details are displayed.

10.4.2 Relay

In the **ANALYZE** output submenu, press **2** to select the **Relay** option . Select the **Relay** option number to view the following parameters:

- Relay name
- Function type
- Status

The LCD screen shows the following list of abbreviations to indicate the status of the relay:

- **DISABLED** indicates a disabled output.
- **ACTIVE** indicates an active output.
- **STANDBY** indicates that an output is in standby.

Select the option number for the respective relay and press **ENTER**. The NAC's details are displayed.

10.4.3 City circuit

Press **3** to select the **City Circuit** option from the **ANALYZE** output submenu. Select the **City Circuit** option to view the city circuit details.

10.5 Annunciator

Press **5** to view the network devices. The A050 and A250 control units support a maximum of eight annunciators. The field network devices status displays the related output status by abbreviations.

For the list of abbreviations, see [Table 31](#).

Table 31: Annunciator status and description

Status	Description
OK!	The net. device is sensed as connected and working
Ko!	The net. device is sensed as not connected
DIS	The net. device is disabled
—	The net. device is not configured in the network
OLD	The net. device has an obsolete FW version

10.6 Gateway

Press **6** to view the gateway connected to the control panel. You can see the following details of **GATEWAY ANALYZE**.

```
1=Gateway Status
2=Configuration Info
3=DACT Test
```

1. Select option **1** for viewing the **Gateway Status**.
2. In the gateway analyze screen, select option **2** to view the gateway configuration option.
3. Select option **1** to view the **Gateway IP** status.
 - a. If configured for Static IP
 - b. If configured for Dynamic IP
4. In the configuration info screen, select the option **2** to view the gateway primary station configuration.
5. In the configuration info screen, select option **3** to view the gateway secondary station configuration.
6. In the gateway analyze screen, select option **3** to perform DACT Test, a test event is sent to the central station.

10.7 Lamp test

Press **7** to select the **LAMP TEST** option. All users can use the **LAMP TEST** option to test the control unit buzzer and LEDs. If the user presses **7** when the control unit is functioning as intended all LEDs glow and the buzzer emits a continuous beep.

10.8 Firmware version

To view the firmware version of the FACU, select **8=FW version** option of the View Parameters menu.

10.9 Panel Info

In the **ANALYZE** menu, press **9** to select **Panel Info**.. Use the **PANEL INFO** option to view the following information:

- The FACU serial number: the electronic board serial number composed of eight hexadecimal digits.
- Job Name: This is the name given to the configuration settings, the default name for a job is 2250-9101 JOB for a 2250 panel and

2050-9101 JOB for a 2050 panel. The user can change the job name with PCSW or mobile app.

- Job Revision Number: This is the revision number after a Job and is incremented by one after changing the configuration from panel / PCSW or mobile app. The job revision number for default configuration of a panel is 00001.
- Date And Time: If a user changes the configuration, the date and time will display in the format of dd/mm/yyyy and hr/min/sec.

11 View list

In the **MAIN** menu, press **2** to select the **VIEW LIST** option.

11.1 Disabled list

In the **VIEW LIST** menu, press **1** to select the **Disabled list** option .

Use the **Disabled list** sub menu to view the following lists:

- To view the list of disabled zones
- To view the list of disabled loop devices
- To view the list of disabled system parts, such as NAC, relay, gateway, annunciator and city circuit.

11.1.1 Viewing disabled zones

To view the list of disabled zones, complete the following steps:

1. Press **2** to select the **View Lists** option.
2. Press **1** to select the **Disabled List**.
3. Press **1** to select the **Disabled Zones** option.

11.1.2 Viewing disabled devices

To view the list of disabled devices, complete the following steps:

1. Press **2** to select the **View Lists** option.
2. Press **1** to select the **Disabled List**.
3. Press **2** to select the **Disabled Devices** option.

11.1.3 Viewing disabled system parts

To view the list of disabled system parts, complete the following steps:

1. Press **2** to select **View Lists**.
2. Press **1** to select **Disabled List**.
3. Press **3** to select **Disabled Sys. Modules**.
4. Use the **UP** and **DOWN** keys to view the previous or next module.

11.2 Viewing the CO/PRI2 list

To view the **CO/PRI2** list, complete the following steps:

1. Press **2** to select **View Lists**.
2. Press **2** to select **CO/PRI2**.

For the **CO/PRI2** list by zone, see [Figure 25](#).

Figure 25: CO/PRI2 event screen by zone

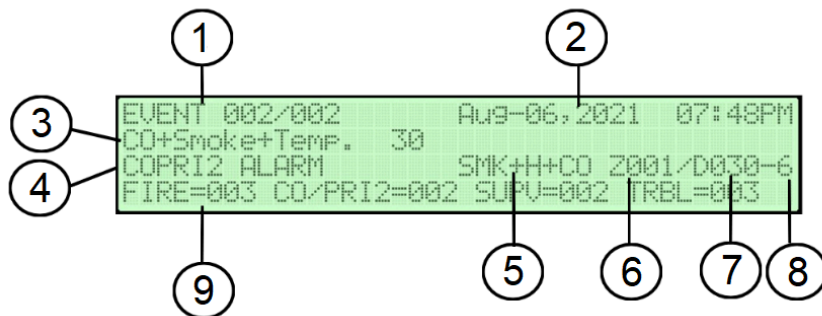

Callout	Description
1	Current CO/PRI2 alarm event / total CO/PRI2 alarm events
2	Date-time of event (MM.DD.YYYY)
3	Device label
4	Device type
5	Event type
6	Zone ID
7	Device address
8	Sub-event type
9	Various event count

11.3 Viewing the Trouble list

To view the trouble list, complete the following steps:

1. Press **2** to select **View Lists**.
2. Press **3** to select **Trouble**. The LCD screen shows the trouble list.

11.4 Viewing the Supervisory list

To view the supervisory list, complete the following steps:

1. Press **2** to select **View Lists**.
2. Press **4** to select **Supervisory**.

For the **Supervisory** list by zones, see [Figure 26](#).

Figure 26: Supervisory event screen

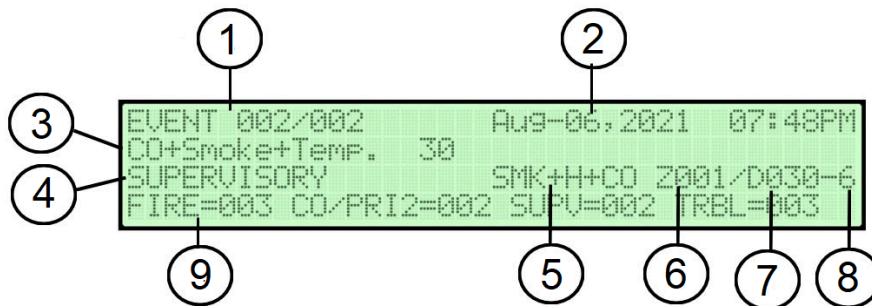

Callouts	Description
1	Current supervisory event /total supervisory event
2	Date-time of event
3	Device label
4	Event type
5	Device type
6	Zone ID
7	Device address
8	Sub-event type
9	Various event count

11.5 Viewing the Zone in walk test

To view the zone in walk test list, complete the following steps:

1. Press **2** to select **View Lists**.
2. Press **5** to select **Zone in walk test**. The LCD screen shows **WALK TEST**.
3. Press the **UP** and **DOWN** keys to view the previous or next zone details.

11.6 Viewing the Device in walk test

To view the device in walk test list, complete the following steps:

1. Press **2** to select **View Lists**.
2. Press **6** to select **Device in walk test**. The LCD screen shows device in walk test by zone.

12 Viewing the log

In the **MAIN** screen, you can directly access the **View Log**. The **Event Class** field displays the class of the event currently displayed, the possible values are:

- RESTORE
- ALARM
- CO/PRI2
- SUPERVISOR
- TROUBLE
- GENERIC
- WALK TEST
- ENABLED
- DISABLED

To view the log, complete the following steps:

1. Press **3** to select **View Log**. The LCD screen shows **Status: VIEW LOG**.
2. Use the **UP** key to view more logs.
3. Use the number keys to view specific events.
 - Press **1** to view **ALARM** events.
 - Press **2** to view **CO/PRI2** events.
 - Press **3** to view **SUPV** events.
 - Press **4** to view **WALK TEST** events.
 - Press **5** to view **TROUBLE** events.
 - Press **6** to view **RESTORE** events.
 - Press **7** to view **GENERIC** events.
4. Press the **RIGHT** navigation key to view log details.

13 Event driven screens

Event driven screens are screens that activate when there is an event in the system. In the case of an event, the event driven screen overrides the screen present on the display at that time.

Event driven screens have different levels of priority. An event driven screen of a higher priority can override an event driven screen that has a lower priority. The following table describes the event driven screen priority assignment.

Table 32: Event driven screen priority assignment

Event driven screen	Priority value
ALARM	0 (highest)
CO/PRI2	1
SUPV	2
TROUBLE	3
WALK_TEST	4 (lowest)

If the control unit is displaying the highest priority event driven screen, an event screen with a lower priority can **not** override the currently displayed highest priority event driven screen. The highest priority event screen, as shown in [Table 32](#), can suppress one or more lower priority event screens. In this condition use the **View list** entry in the **MAIN** screen to access the suppressed event screens.

13.1 Alarm screen

To signal Alarm or CO/PRI2 or SUPV events, a common screen is used.

Figure 27: Alarm event screen by zone

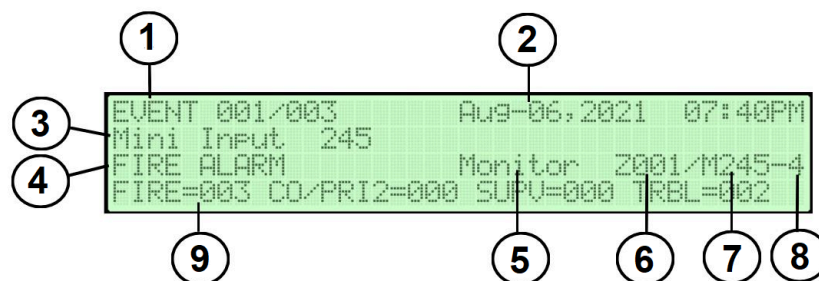

Callout	Description
1	Currently displayed alarm event index/ Total alarm events present
2	Date-time of event
3	Device label
4	Control unit status
5	Device type
6	Zone ID
7	Detector/Module (D=Detector, M=module) ID
8	Cause index 1=Smoke 2=Heat/Temp 3=CO 4=Digital input 5=Manual input 6=Reed switch
9	Events counts

The control unit status can assume the following values:

- FIRE ALARM
- CO/PRI2 Alarm
- SUPERVISORY

Press **ACK** to display alarm event.

For information about the keys to use in the **Alarm** screen, see [Table 33](#)

Table 33: Alarm screen key information

Key	Action
1	To jump to the zone status visualization screen, only the zone in Alarm is displayed.
2	To jump to the first activated loop device status visualization screen.
UP	<ul style="list-style-type: none"> To display the previously available point in alarm. To roll over from first to last alarm event.
DOWN	<ul style="list-style-type: none"> To display the next available point in alarm. To roll over from first to last alarm event.
ESC	Moves the UI to the summary screen.

- Press **1** to display the Zone status visualization screen.

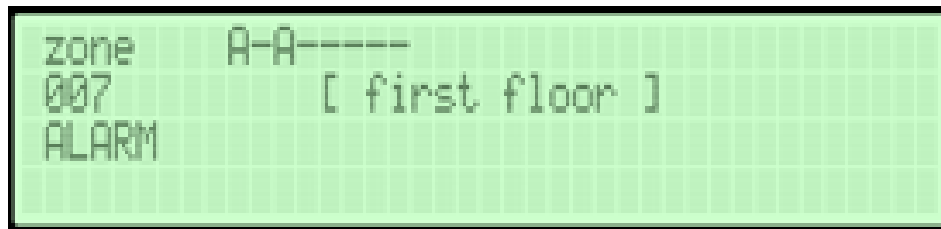
Figure 28: Alarmed zone overview

- Press **2** to display the activated loop device status visualization screen.

Figure 29: Status of the device related to the event

- Use the **UP** and **DOWN** keys to display the information for the previous / next points and to rollover from first to last or last to first alarm event
- Press **ESC** to return to the summary screen or wait for the 26 secs timeout.

(*) only the zone in Alarm will be displayed. In the case of alarm displayed by zone the process is similar except for the jump to the single zone status screen because this screen does not exist. Press **1** to jump to the all zones status screen. Press **ESC** to return.

13.2 CO/PRI2 screen

The **CO/PRI2** or **SUPV** screen is basically the same as the **Alarm** screen. The only differences involve the third row of the display.

13.3 Trouble screen

In the case of a trouble that is related to a loop device, instead of system area trouble, the device label is displayed.

Figure 30: Device related trouble screen

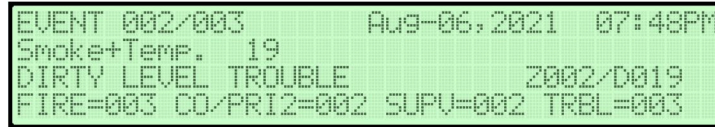
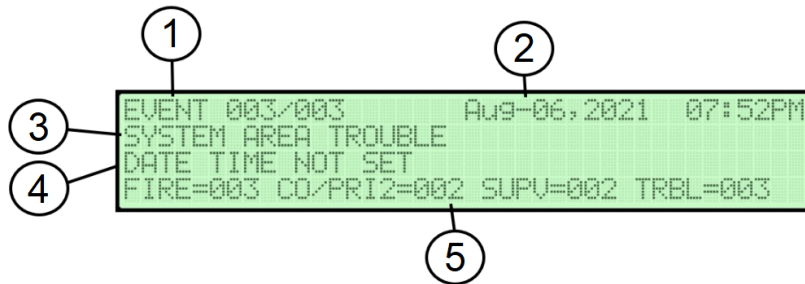

Figure 31: Event driven trouble screen



Callouts	Description
1	Current trouble index and Troubles counter
2	Date-time of trouble event
3	System area trouble or Device label
4	Trouble event
5	Events counts

For information about the keys to use in the **Trouble** screen, see [Table 34](#).

Table 34: Table screen options

Key	Action
1	To jump to the Zone status visualization screen
2	If the first trouble is related to a point, jump to loop device status visualization screen If the first trouble is a loop break trouble, jump to the locate the loop break screen For a fast disablement procedure, if the first trouble is related to an item that can be disabled, the UI moves to the disabling screen (*).
UP	To display the prev. available trouble, other than the first and the last
DOWN	To display the next available trouble. To roll over from last trouble to first trouble.
ESC	Moves the UI to the summary screen.

13.4 Walk test screen

The **WALK TEST** screens function the same as the **Alarm** screen. The only difference between the **WALK TEST** screens and the **Alarm** screen is the **Control unit status** field that is **WALK TEST** respectively. Furthermore, it is not possible to activate the fast disabling procedure in the case of items that might be disabled.

14 Diagnostics

14.1 Overview

This section displays the status of the control unit and the different devices connected to the control unit.

- **Panel meter** screen: displays electrical parameters inside the control unit.
- **Loop** screen: displays functional parameters related to the loops.
- **Keyboard test** page: to execute the control unit keyboard test.

The **Panel meter**, **Loop** and **Keyboard test** screens are accessible during normal operation on the **MAIN** screen when you long press **4**

To access the **Panel meter**, **Loop** and **Keyboard test** screens, complete the following steps:

1. In the **MAIN** screen, long press **4** to access the **Panel Meter** screen.
2. Press the **RIGHT** navigation key to access the **LOOP** screen.
To return to the **Panel meter** screen, press the **LEFT** navigation key.
3. In the **Loop** screen, press **ENTER** to access the **KEYBOARD TEST** screen.
4. In the **Loop** screen, press **RIGHT** to access **NAC Current status** screen.
5. Long press **ESC** to return to the **MAIN** screen.

14.2 Panel meter screen

The **Panel Meter** screen displays the following information:

- **V-PSU** displays the output voltage of the control unit power supply.
Measure range: 0 VDC to 30 VDC accuracy $\pm 5\%$.
- **I-SYS** displays the output current of the control unit power supply.
Measure range: 10 mA to 15000 mA accuracy $\pm 5\%$.
- **Vbatt.** displays the battery voltage.
Measure range: 0 VDC to 30 VDC accuracy $\pm 5\%$.
If the battery voltage is 0 V, it displays **NO BATTERY**.

14.3 Loop diagnostic screen

The **LOOP** diagnostic screen is a general purpose screen that displays the values of loop communication parameters in real time.

The rows labeled **A** and **B** display the average, minimum and maximum value of the FW parameter related to them.

The rows labeled **C** counts the occurrence of event related to the assigned FW parameter.

The assignment of the FW parameters to be displayed is hardwired in the code, not user selectable.

Press **0** to reset all the displayed values.

14.4 Keyboard test

The **KEYBOARD TEST** screen is for testing all the keys in the control unit's User Interface. If any key is pressed, the relevant portion in the display is blanked. To exit from this screen, long press **ESC**.

14.5 NAC current consumption

The **NAC Current status** screen displays current consumption of each NAC in the system. To exit from this screen, press **ESC**.

15 Event list

Table 35 describes the event message problems.

Table 35: Event list information

Message	Problem
AC Fail	The Control unit is NOT powered from the Mains
Missing / Depleted BATT	The Control unit battery missing or depleted
LOW BATTERY	The Control unit batteries are empty
POSTIVE GROUND	Leakage to Positive Earth
NEGATIVE GROUND	Leakage to Negative Earth
CHARGER TROUBLE	Battery charging trouble
CHARGER DISABLED	Battery charger disabled due to over current
AUX1 Output	AUX1 Output is shorted
AUX2 Output	AUX2 Output is shorted
Flash writing	Flash writing error
Flash erasing	LOG erasing error
Firmware main contr.	Checksum fault
Prog.datamain cont	Data programming Checksum fault
Prog.dataaux.board	Aux Controller data programming Checksum fault
Loop Communication	Communication Loop fault controller
Not programmed dev	Loop device without address
Loop return open	Loop negative signal open
Loop signal open	Loop positive signal open
Loop local short	Local short on Loop controller
Loop right short	Right side Loop short
Loop left short	Left side Loop short
LOOP INTERFACE	The devices on the loop do not communicate correctly with the control unit.
LOOP NOISY	(Check the quality of wiring)
No answer	Loop device does not answer
Dirty level	(Smoke detector ONLY) the dirty threshold has been exceeded
Short circuit	Short circuit on Input module
Open circuit	Open circuit on Input module
Power supply	Main fault
Wrong value	A Loop device has an incorrect value
OUTPUT STUCK	An Output module relay is not switched
Same address	Several loop devices have the same address
Wrong type	Different loop device from that programmed in the control unit
NACx short	NACx= (2050 - 1 or 2; 2250 - 1/2/3/4) short circuit
NACx open	NACx= (2050 - 1 or 2; 2250 - 1/2/3/4) open terminal
NACx Over-current	NACx= (2050 - 1 or 2; 2250 - 1/2/3/4) Over-current
Ax : ANNUNCIATOR COMMUNIC	Annunciator on the RS485 does not respond (x from 1 to 8)

Table 36: Event list information

Message	Problem
DEFAULT DATA	The fire control unit resets to default data
CITY1 TROUBLE	Trouble on City 1 output
CITY2 TROUBLE	Trouble on City 1 output
CITY NOT PRESENT	City card is not present
Date and Time not set	Date time not set
Panel Password	Incorrect control unit password
Main Over-current	NAC current combined to be greater than 9A
NAC x DISABLED	NAC x= (2050 - 1 or 2; 2250 - 1/2/3/4) disabled
RELAY x DISABLED	Relay x = 1,2,3 disabled
ANNUNC x DISABLED	Annunciator x = 1 to 8 Disabled
ZONE x DISABLED	Zone x = (2050 - 1 to 50; 2250 - 1 to 125) disabled
DEV x DISABLED	Device x = (2050 - 1 to 50; 2250 - 1 to 250) disabled
CITY CKT DISABLED	City circuit disabled

Table 36: Event list information

Message	Problem
SB dxxx DISABLED	Sounder base x = (2050 - 1 to 50; 2250 - 1 to 250) disabled
COLD START MAIN	After power ON or default data
COLD START AUX	After power ON or default data
WRONG ENTRY EXCEEDED	3 consecutive incorrect password entries
SERVICE MODE	Access level 2 or 3
BASE UNUSABLE	Detector NO ANSWER associated with sounder base
GATEWAY CONFIGURE	Gateway ON but not configured
PRIMARY PATH	Primary path failure
SECONDARY PATH	Secondary path failure

Note:

1. If the incorrect password is entered three consecutive times, then the control unit shows **Wrong Password** message, event is logged into the memory and information is transmitted to the central station through the gateway.
2. If the user does not change the default date and time after a power reset, then the **Date and Time not set** message will be displayed and an event will be logged into the memory.
3. If control unit is in over current state, all notification devices, AUX power supplies will be OFF for one second and the control unit goes into troubleshooting mode. In this mode, the control unit activates the AUX power supplies first, then the notification devices activate one after the other. If the over current state still persists, then the control unit deactivates the next notification device.
4. If any notification device is in an over current state the control unit deactivates that particular zone or NAC. The LCD screen shows an over current message, logs the event into the memory and transmits the information to the central station.
5. If any loop device or peripheral device is disabled, the control unit will be in trouble state, the event will be logged into the memory and information will be transmitted to central station

16 Delays and threshold

This section describes the control unit's timers and delays and can be configured through Autocall PCSW console only.

16.1 Water flow retard

If selected, this option delays the activation of a water flow type alarm for a programmable time duration from 0 to 90 seconds. This delay is in addition to any time delay inherent in the water flow device. This configuration is possible through PC software.

16.2 AC loss delay

The reporting of a loss of AC power to a central station can be delayed by programming the length of the required delay. The factory default setting is two hours and you can configure it from 1 to 24 hours through personal computer SW.

16.3 Trouble reminder

If selected, this feature causes a reminding audio (control unit buzzer) every four hours (by default) during a trouble condition, (after you press the **ACK** key). The beeps from the onboard piezo buzzer will occur until fault is cleared or **ACK** key is pressed

Note: If the trouble is not cleared in less than 24 hours, the piezo will resound, indicating that the trouble condition still exists. This configuration (1 to 24 hours) is possible through personal computer software.

16.4 Alarm reminder

If selected, this feature causes a reminding audio control unit buzzer and notification devices every four hours during an alarm condition, (after you press **SILENCE**).

Note: If the alarm is not cleared in less than 24 hours, the audio or visual devices will resound, indicating that the alarm condition still exists. This configuration (1 to 24 hours and default value is 4) is possible through personal computer software.

17 Troubleshooting screens

Locate loop break screens are used to manage the **locate loop break** procedure that help to understand where the loop is broken giving as result the number of sensed detector on the left and on the right side of the analyzed loop.

To locate the loop break, complete the following steps:

1. Select **1 = Program** to enter Programming Menu
2. Select **1 = Auto** to do enrolling
3. If Loop break is present the LCD screen shows the following, **Found breaks on:**
4. Press **ENTER** to execute the locate loop procedure. When in progress, the LCD screen shows, **Locate the loop break on: IN PROGRESS**
5. Press **ENTER** to restart the loop break procedure or press **ESC** to go to the **MAIN** menu.

Note: During the **locate loop break** procedure, all the detectors are powered down, so at the exit of the procedure a full loop initialization is executed.

Figure 32: Loop break procedure

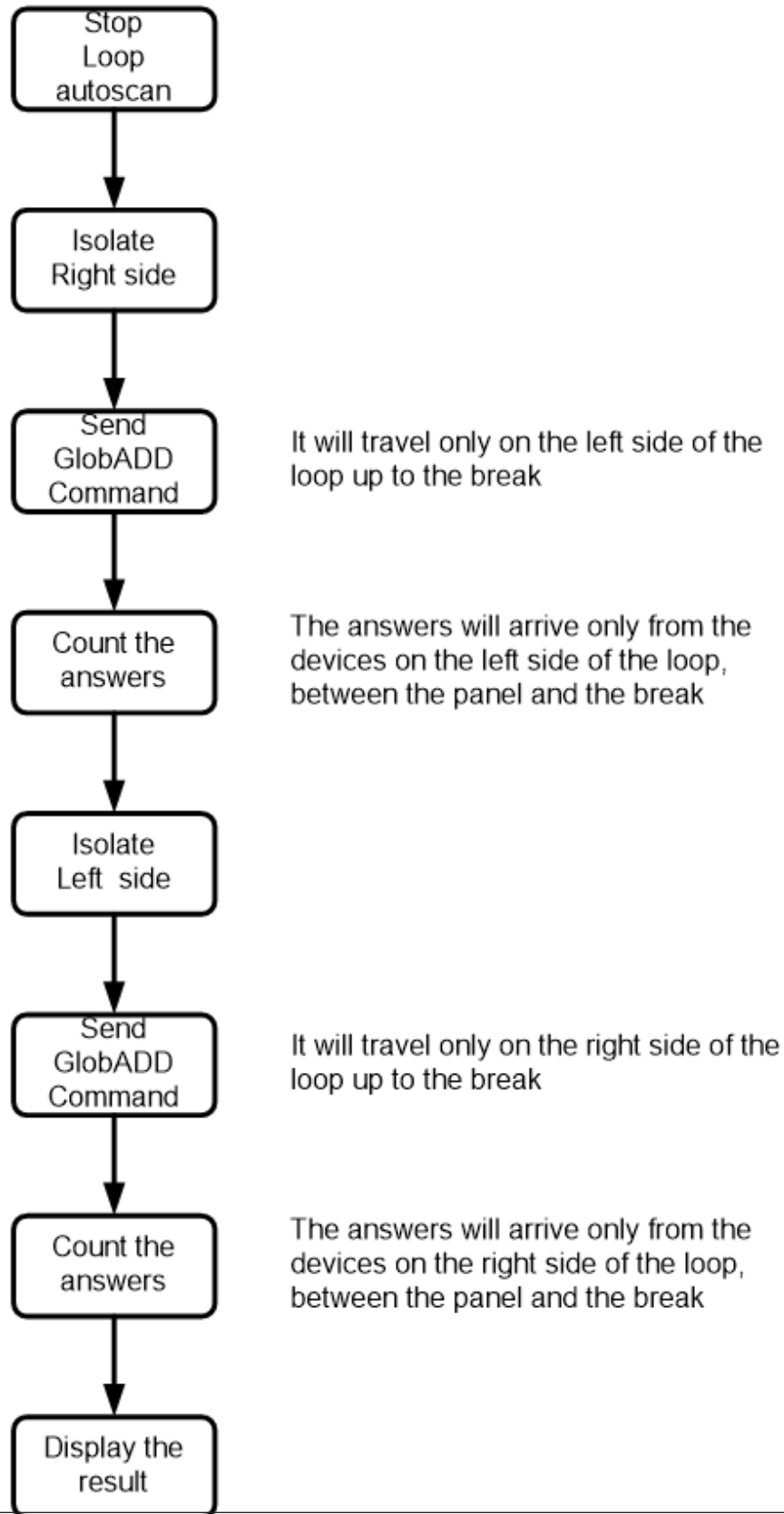

18 Notice to users installers, AHJ, and other involved parties

This product incorporates field programmable software. In order for the product to comply with the Standard for Control Units and Accessories for Fire alarm systems, UL864, certain programming features or options must be limited to specific values or not used at all as indicated in the following Table.

Program feature or option	Permitted in UL864? (Y/N)	Possible settings	Settings permitted by UL
Alarm Reminder Setting Option	Y	1 h to 24 h (Default 4 h)	1 h to 24 h
CO/Pri-2 Reminder Setting Option	Y	1 h to 24 h (Default 4 h)	1 h to 24 h
Supervisory Reminder Setting Option	Y	1 h to 24 h (Default 4 h)	1 h to 24 h
Trouble Reminder Setting Option	Y	1 h to 24 h (Default 4 h)	1 h to 24 h
AC Fail delayed reporting to the central station	Y	1 h to 24 h (Default 2 h)	1 h to 3 h
Test Report Period	Y	1 h to 24 h (Default 2 h)	6 h
Panel display language setting	Y	Display in English, Spanish and Portuguese Languages.	Display in English language only
System Disable setting	Y	Loop devices, SW Zones, NAC, Relays, City Circuit, Annunciator, GW module.	None

18.1 Locating not addressed devices

- In the case of **NOT PROGRAMMED DEV**, trouble you can locate all the non-addressed devices.
- To make visible all the not addressed devices that have a LED, they will be activated (steady on).
- The following pictures display the **locate not addressed device** screen diagram flow.
- If there are too many not addressed devices, the overall current required to keep active all the LEDs, sounders and beacons at the same time, can be so high that the loop overcurrent protection circuit is triggered. For this reason the operator is warned about this possibility.

To locate devices that are not addressed, complete the following steps:

1. In the trouble window, press **2** to view the procedure.
2. Press **ENTER** to view not addressed devices, the device LED is steady on.
3. Press **SILENCE** to stop or press **ESC** to return to the **MAIN** menu. When you silence the devices, the LCD screen shows the following, **Devices silenced**.

Note: This feature is only available when the control unit reaches its stand-by status (ACTIVE).

18.2 Device replacement

This feature is called from the trouble screen in the case —NO ANSWER loop device trouble pressing the shortcut key **2**.

The panel assumes that at the launch of the procedure, that only one not addressed device is present over the loops (address = 0xFF). It will then assign at this not addressed device, the stored address.

To replace a device that displays **NO ANSWER** the following steps needs to be followed:

1. Connect a new device of same type with address 255.
2. Press **2** To enter the device replacement procedure.
3. Press **ENTER** to Execute
 - If replacement is successful, the LCD screen shows the following, **Replacement done**
 - If replacement is not successful, the LCD screen shows the following, **Replacement FAILED**, the panel can display four types of issues depending upon the situation. Refer to the following note.

Possible errors:

- **No Answer:** no devices are sensed at address 0xFF (most likely no replacement device connected or replacement device already addressed)
- **Wrong answer:** the received answer from device at address 0xFF is corrupted (most likely more than one device at address 0xFF are connected)
- **Wrong type:** the case of type verification test fail.
- **Add. not assigned:** is displayed in the case of fail of the address setting activity.

The panel verifies that the type of the device used as replacement is exactly the same of the replaced device

18.3 Double addressed devices

To locate double addressed devices, complete the following steps:

1. Press **ENTER** to view the devices. The device LED is steady on. **Double addresses: Locate them?**
2. Press **SILENCE** to stop or press **ESC** to return to the **MAIN** screen, **Double addresses Devices visible**

When you silence the devices, the LCD screen shows the following,

Double addresses: Devices silenced

19 Walk test

WALK TEST is for testing the function of the system's initiating devices and signals by a person.

Press **WALK TEST** to configure **WALK TEST** feature.

After the programming is completed, the system **TROUBLE** LED starts flashing indicating **WALK TEST** is ACTIVE.

Conducting a Walk Test requires user to perform the following general steps:

1. Press **WALK TEST** and select zones to put in Walk Test mode.
2. Select any of the following options
 - **YES** To select all zones.
 - **NO** To select specific zones.
3. After zones have been selected, select any of the following device setting options.
 - **off** No device selection
 - **ALL** To select all devices
 - **det** To select detectors only
 - **ps** To select pull stations only
4. When the user selects any option other than **OFF**, the process moves to select Notification setting.
5. Select any of the following NAC setting
 - **YES** Respective notification devices will be activated when the user activates the initiating devices in test mode.
 - **NO** The notification devices will not activate when user activate the devices in test mode. The system treats this option as a silenced walk test.

Note:

- The presence of a zone in **WALK TEST** mode is signaled by the **TEST** yellow LED on the User Interface.
- More than one zone can be put in **WALK TEST** mode at the same time.
- Activation of each detector or pull station in **WALK TEST** mode is logged as a test event in the log memory.
- Disabled NAC devices do not activate during walk test.
- Addressable devices are monitored for fault conditions during **WALK TEST** mode. When a new trouble condition occurs, the control unit activates all NACs and control modules programmed for **WALK TEST** and mapped to the faulty device, then shuts them off after eight seconds
- While in **WALK TEST**, the trouble relay is activated and the system **TROUBLE** LED flashes, as in all of the Program and status change operations. The alarm relay is not activated.

