

NOTES:

1. Mounting frame kit includes mounting frame and 4 x 4 x 1-1/2 box extension.
2. Mounting frame attaches to unit around return/access opening.
3. Recessed panel frame attaches to mounting frame.
4. Single device tile ring ships attached to front of unit.
5. See drawing VH-014 for recessed wall panel assembly details.
6. Mounting hardware is shipped loose for field installation. Refer to instructional drawing VH-106 for details.

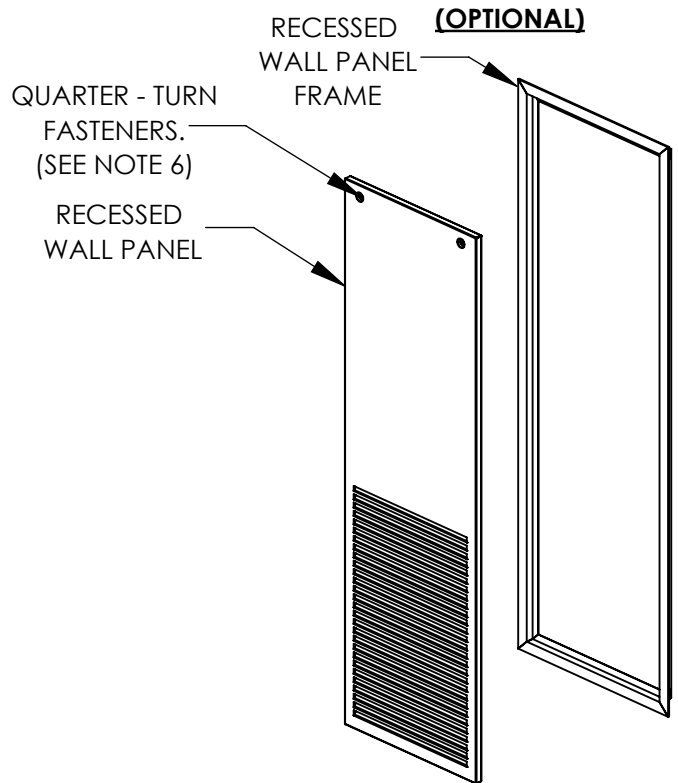
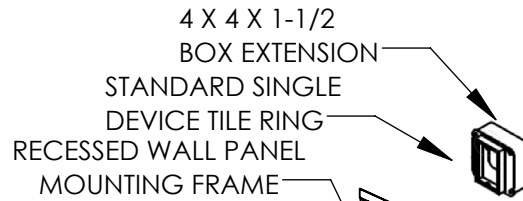
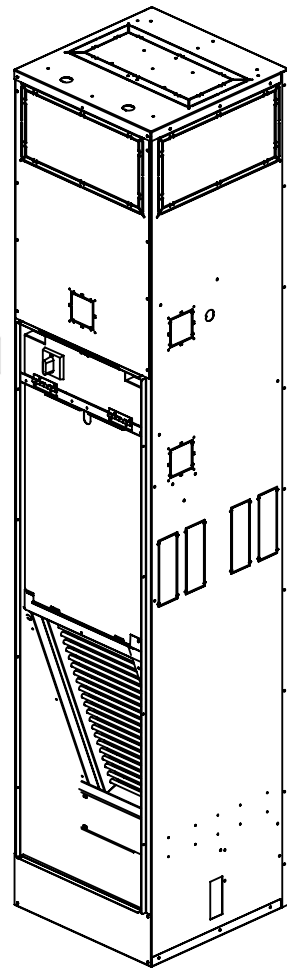

OPTIONAL MOUNTING FRAME

RECESSED MOUNTING FRAME

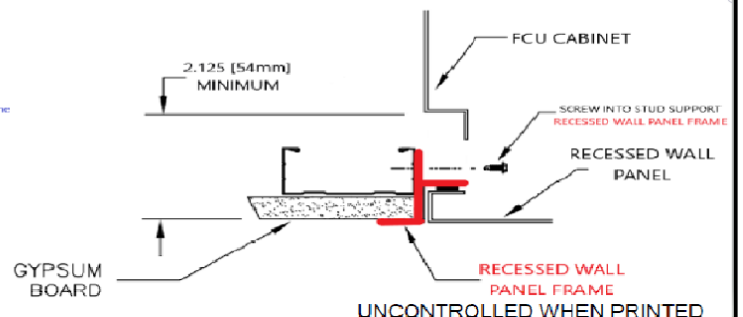
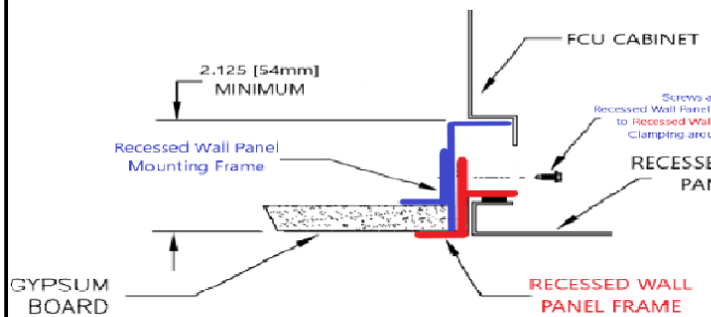

UNCONTROLLED WHEN PRINTED



THIS DRAWING CONTAINS PROPRIETARY DATA. UNAUTHORIZED DISCLOSURE, REPRODUCTION, OR USE IS STRICTLY PROHIBITED WITHOUT WRITTEN PERMISSION.

SUBMITTAL DRAWING ALL DRAWINGS ARE SUBJECT TO CHANGE WITHOUT PRIOR NOTICE		TITLE: MODEL "VH" VERTICAL HIGH RISE FAN COIL UNIT RECESSED WALL PANEL OPTIONAL MOUNTING FRAME KIT		
DO NOT SCALE DRAWING DIMENSIONS ARE IN INCH (MM) FORMAT +/- 1/8 (3) UNLESS OTHERWISE NOTED	DATE 10/31/23	SHEET PAGE 1 OF 4	DRAWING NO VH-021	REV A

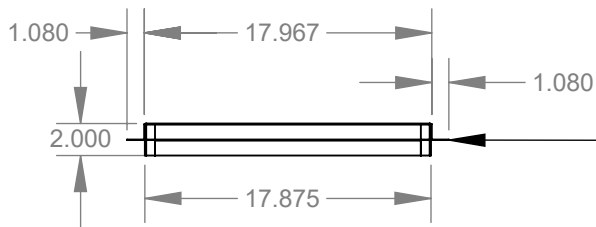

RECESSED WALL PANEL MOUNTING FRAME

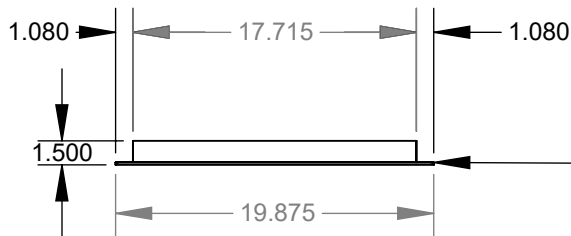

RECESSED WALL PANEL FRAME

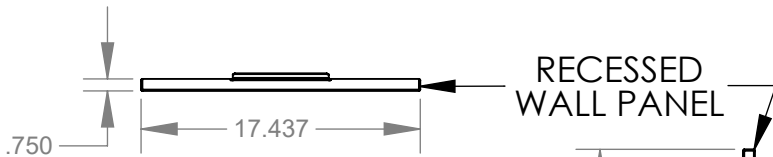

RECESSED WALL PANEL

UNIT SIZE 03/04

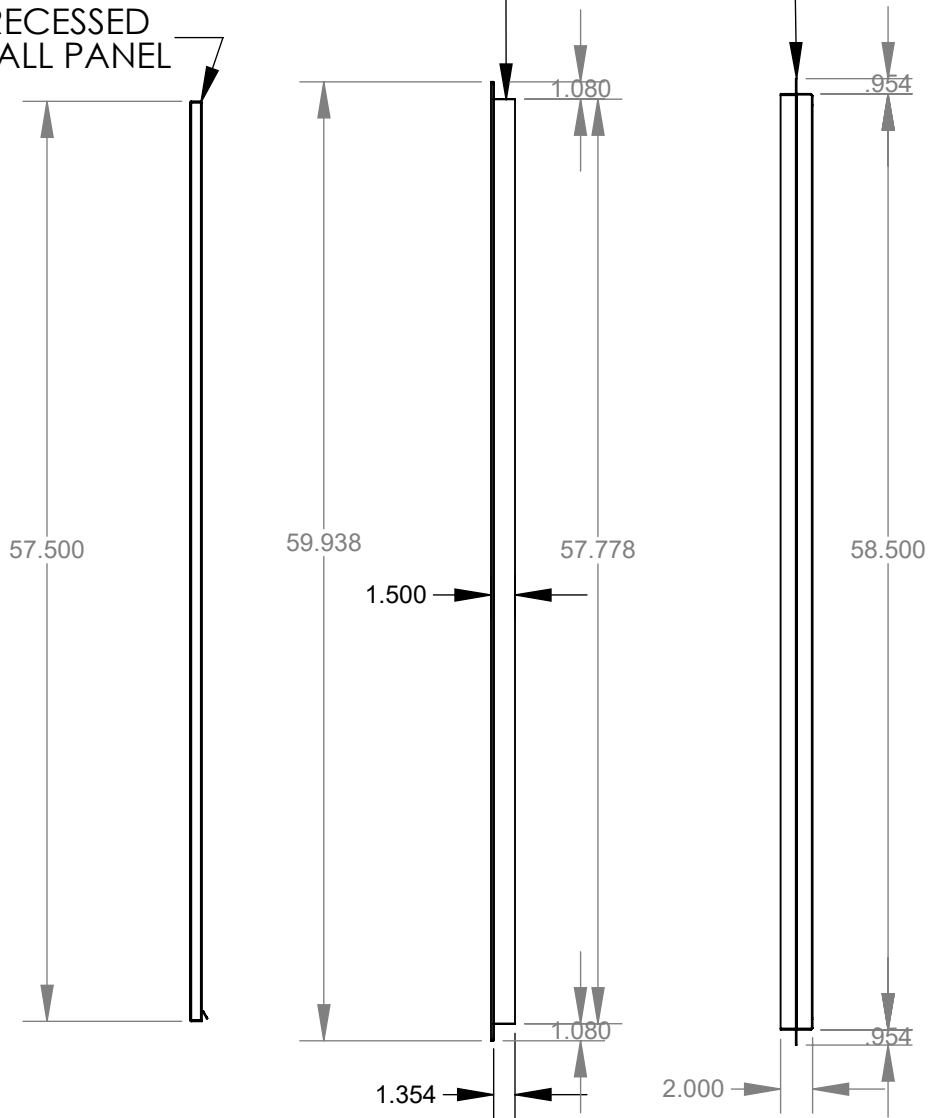

UNCONTROLLED WHEN PRINTED



ENVIRO-TEC

THIS DRAWING CONTAINS PROPRIETARY DATA. UNAUTHORIZED DISCLOSURE, REPRODUCTION, OR USE IS STRICTLY PROHIBITED WITHOUT WRITTEN PERMISSION.

SUBMITTAL DRAWING
ALL DRAWINGS ARE SUBJECT TO CHANGE WITHOUT PRIOR NOTICE

DO NOT SCALE DRAWING
DIMENSIONS ARE IN INCH (MM) FORMAT
+/- 1/8 (3) UNLESS OTHERWISE NOTED

TITLE: **MODEL "VH" VERTICAL HIGH RISE FAN COIL UNIT RECESSED WALL PANEL OPTIONAL MOUNTING FRAME KIT**

DATE	SHEET	DRAWING NO	REV
10/31/23	PAGE 2 OF 4	VH-021	A

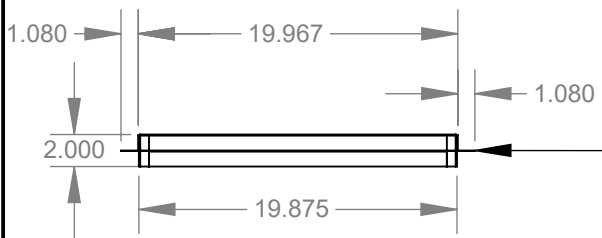

RECESSED WALL PANEL MOUNTING FRAME

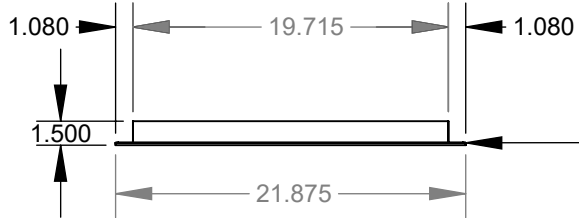

RECESSED WALL PANEL FRAME

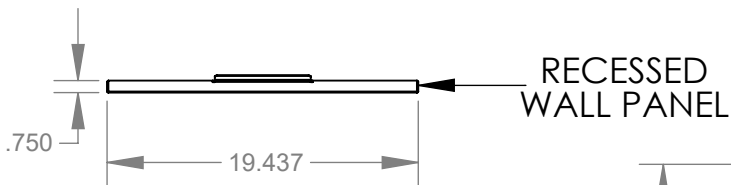

RECESSED WALL PANEL

UNIT SIZE 06/08

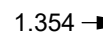
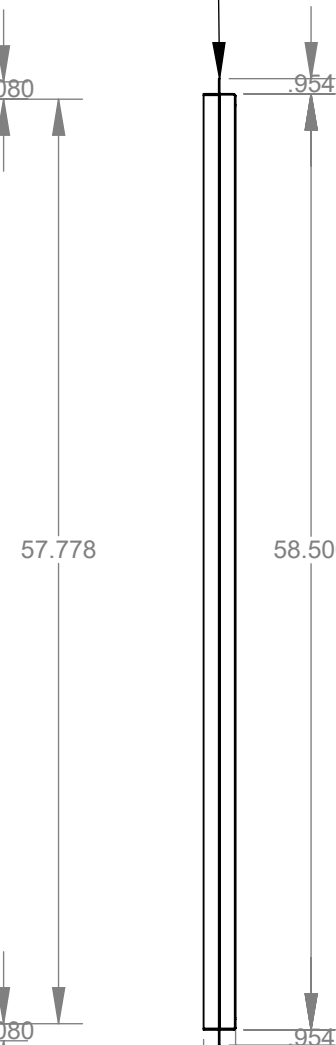
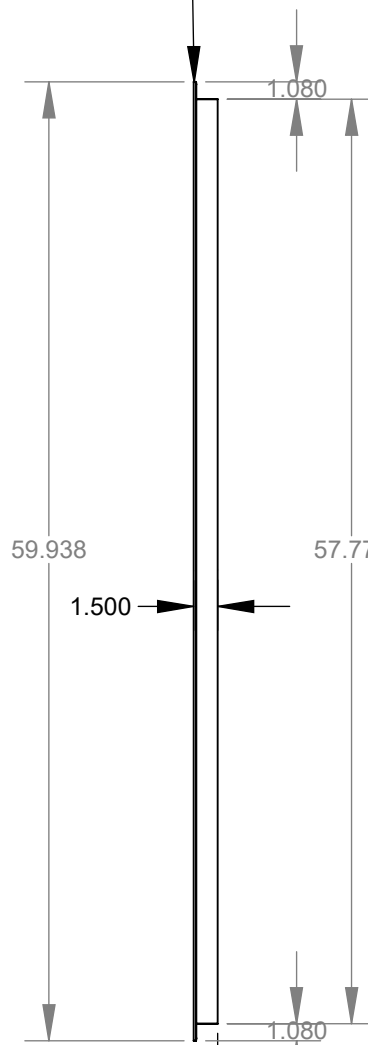

UNCONTROLLED WHEN PRINTED



ENVIRO-TEC

THIS DRAWING CONTAINS PROPRIETARY DATA. UNAUTHORIZED DISCLOSURE, REPRODUCTION, OR USE IS STRICTLY PROHIBITED WITHOUT WRITTEN PERMISSION.

SUBMITTAL DRAWING
ALL DRAWINGS ARE SUBJECT TO CHANGE WITHOUT PRIOR NOTICE

DO NOT SCALE DRAWING
DIMENSIONS ARE IN INCH (MM) FORMAT
+/- 1/8 (3) UNLESS OTHERWISE NOTED

TITLE: **MODEL "VH" VERTICAL HIGH RISE FAN COIL UNIT RECESSED WALL PANEL OPTIONAL MOUNTING FRAME KIT**

DATE	SHEET	DRAWING NO	REV
10/31/23	PAGE 3 OF 4	VH-021	A

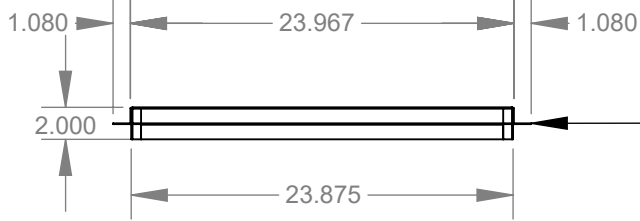

RECESSED WALL PANEL MOUNTING FRAME

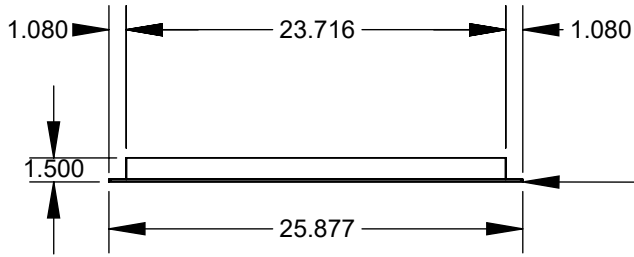

RECESSED WALL PANEL FRAME

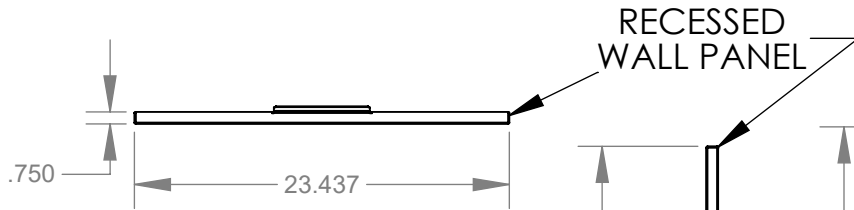

RECESSED WALL PANEL

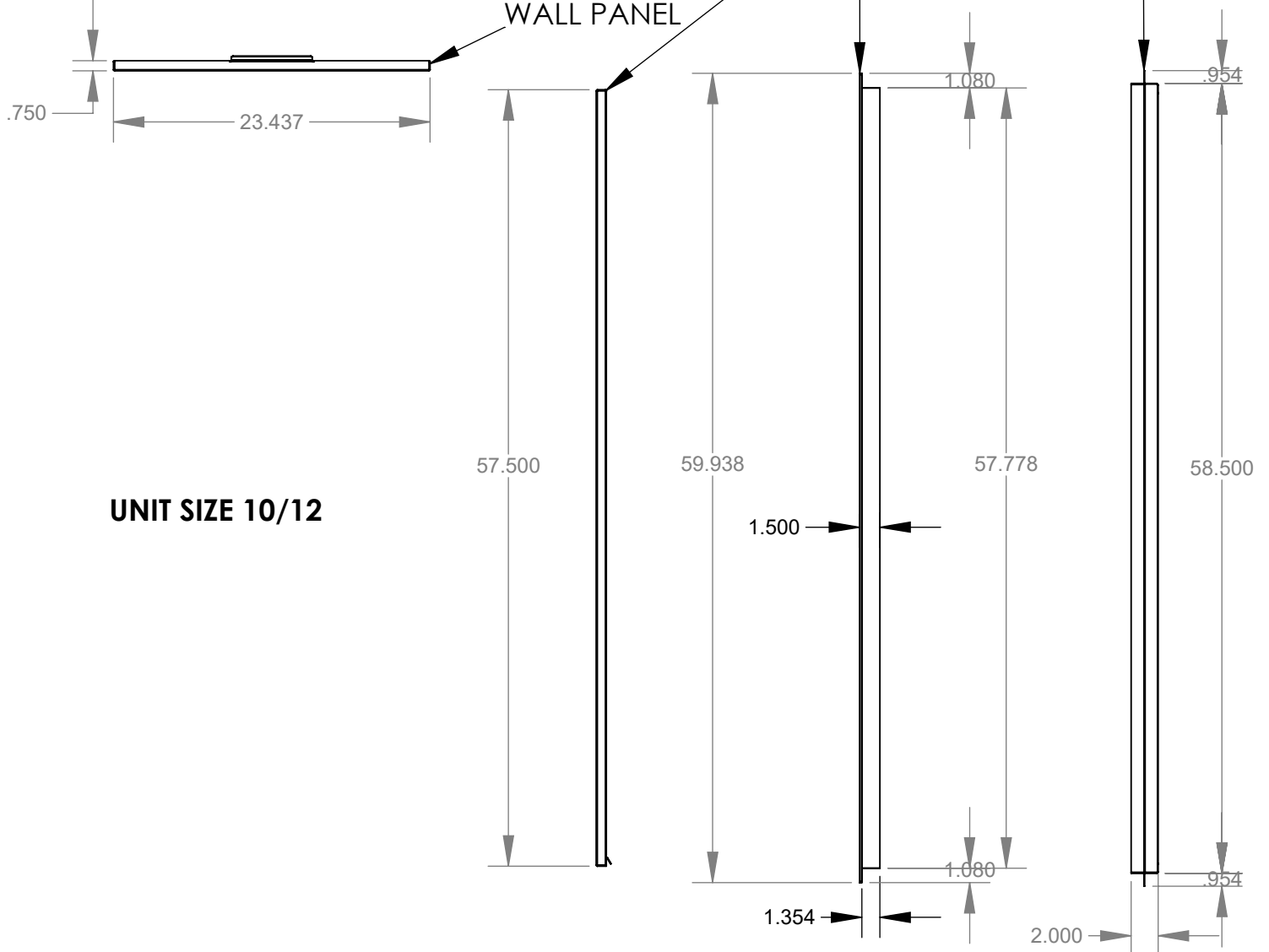

UNIT SIZE 10/12

UNCONTROLLED WHEN PRINTED



ENVIRO-TEC

THIS DRAWING CONTAINS PROPRIETARY DATA. UNAUTHORIZED DISCLOSURE, REPRODUCTION, OR USE IS STRICTLY PROHIBITED WITHOUT WRITTEN PERMISSION.

SUBMITTAL DRAWING
ALL DRAWINGS ARE SUBJECT TO CHANGE WITHOUT PRIOR NOTICE

DO NOT SCALE DRAWING
DIMENSIONS ARE IN INCH (MM) FORMAT
+/- 1/8 (3) UNLESS OTHERWISE NOTED

TITLE: **MODEL "VH" VERTICAL HIGH RISE FAN COIL UNIT RECESSED WALL PANEL OPTIONAL MOUNTING FRAME KIT**

DATE	SHEET	DRAWING NO	REV
10/31/23	PAGE 4 OF 4	VH-021	A