

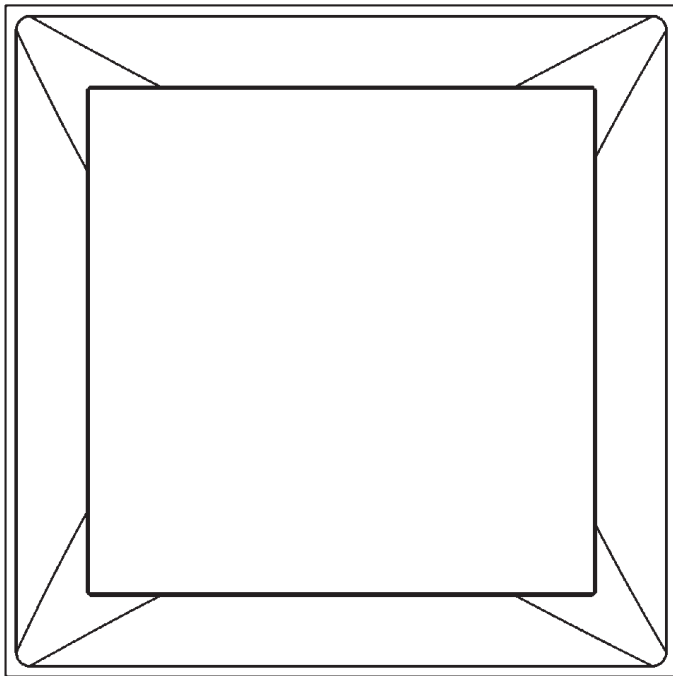

# PRODUCT DIMENSIONS

## DCVH

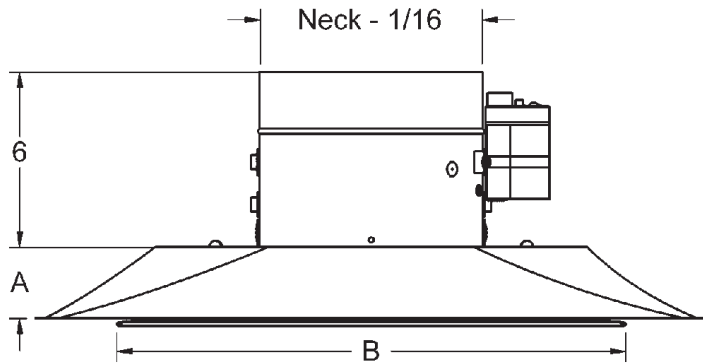

### Frame Styles

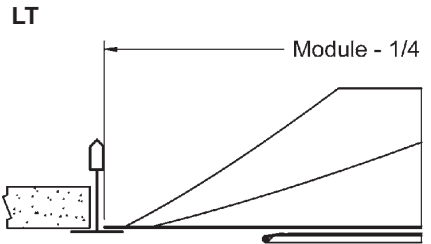

NR (9/16 Tee with 5/16 Drop)

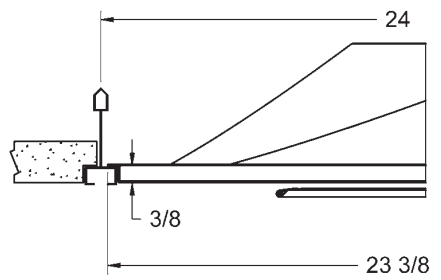

PL

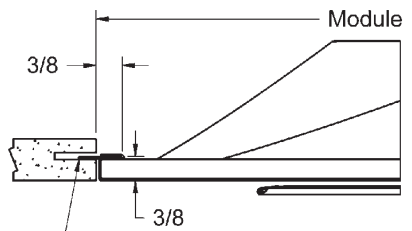

Spline Hardware Not Included

SF

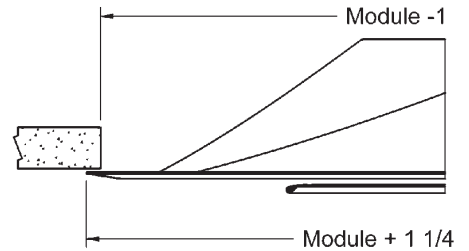

Module	Neck	A	B
12x12	6, 8	1-1/8	9
24x24	6, 8, 10, 12, 14	2-1/2	18



# PRODUCT DIMENSIONS

DCVH

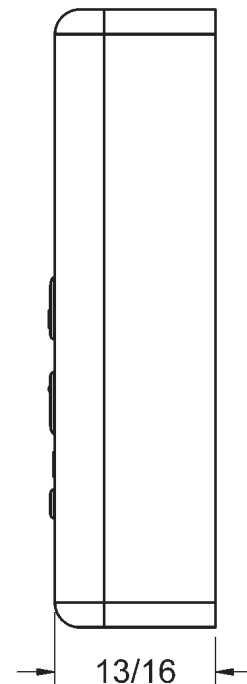
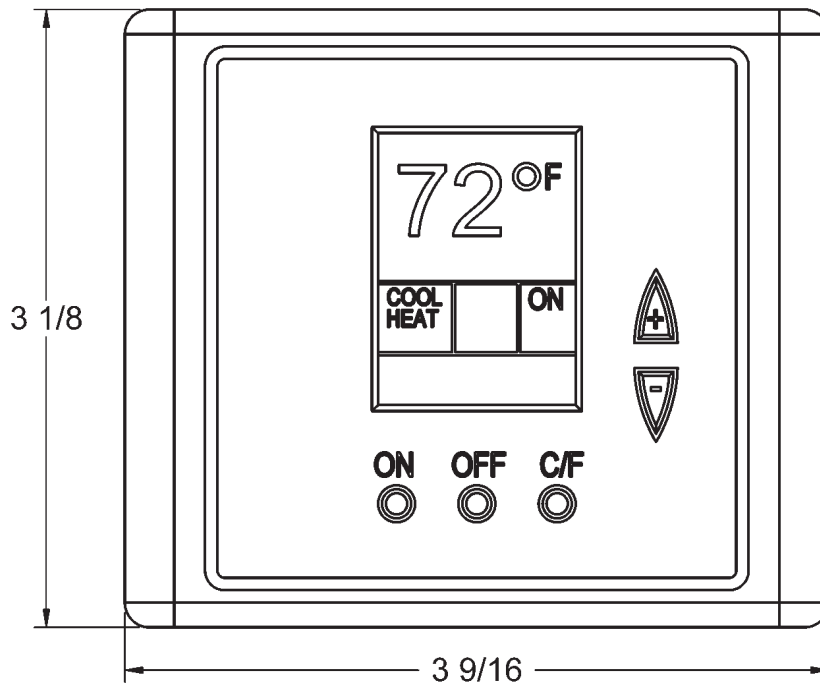
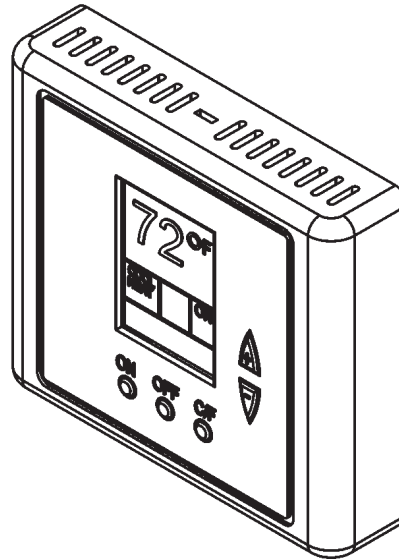



# PRODUCT DIMENSIONS

## DCVH

### Wiring Diagram

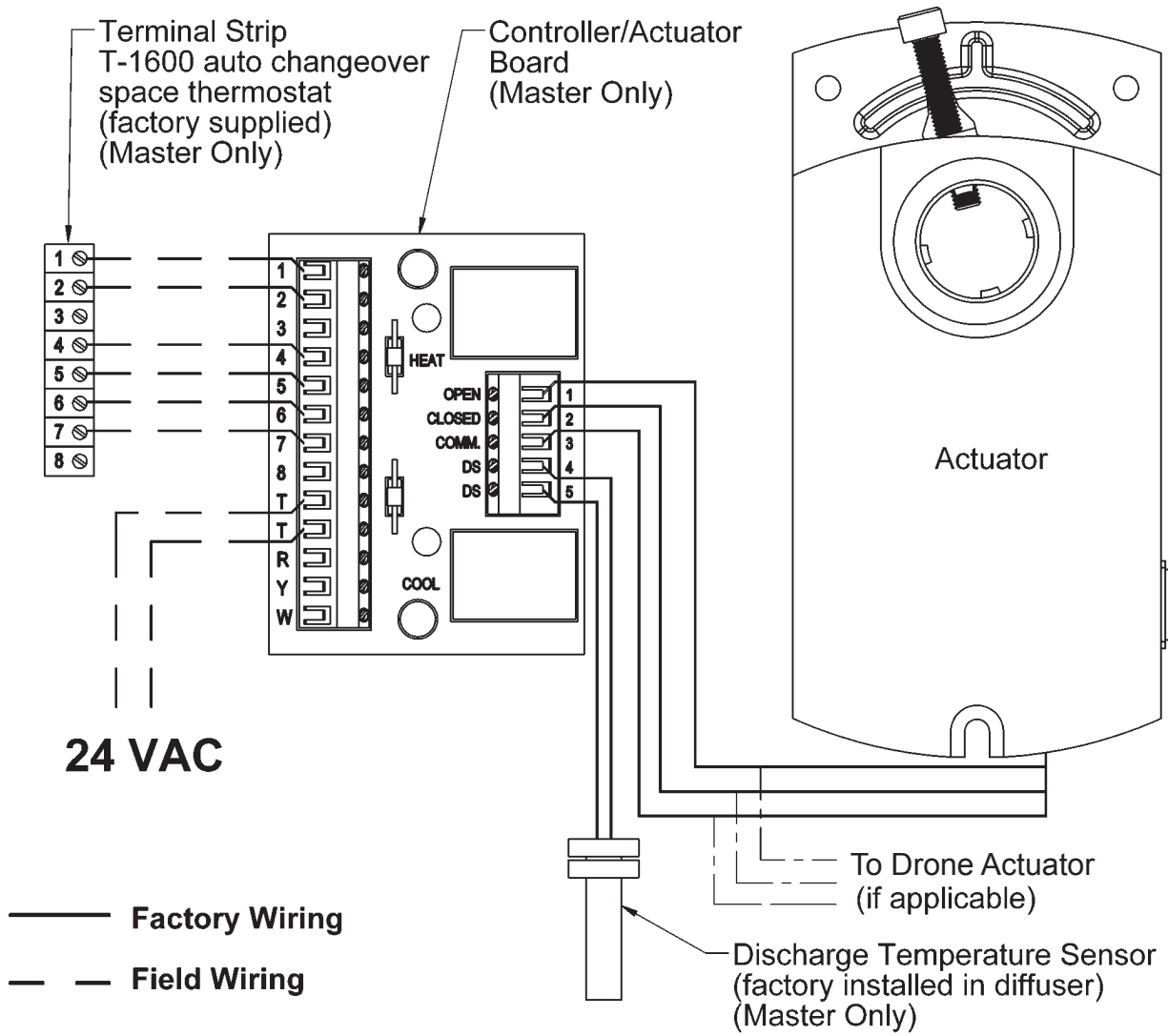

Specialty  
Products