

NOTES:

1. All dimensions are Inches [millimeters].
All dimensions are $\pm 1/4"$ [6mm]. Metric values are soft conversion.
2. Left hand unit shown.
Motor/drive location may be specified Left or Right Hand. Standard control enclosure location matches motor/drive position.
Enclosure sizes varies with option.
3. Provide sufficient clearance to access electrical controls and comply with all applicable codes and ordinances.
4. Optional base rail designed for use with floor mount vibration isolators.

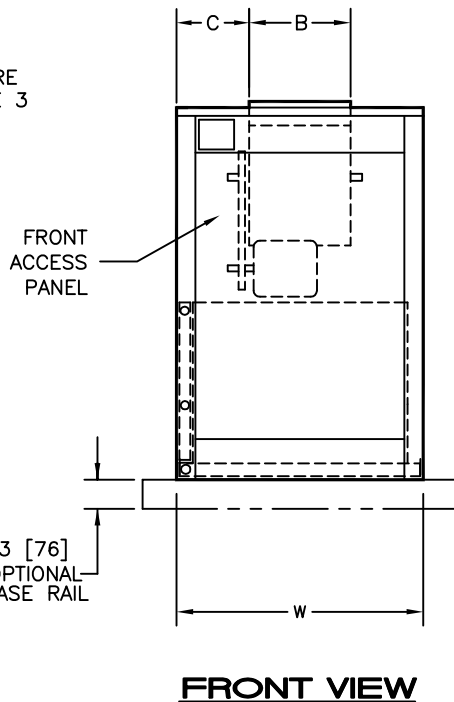
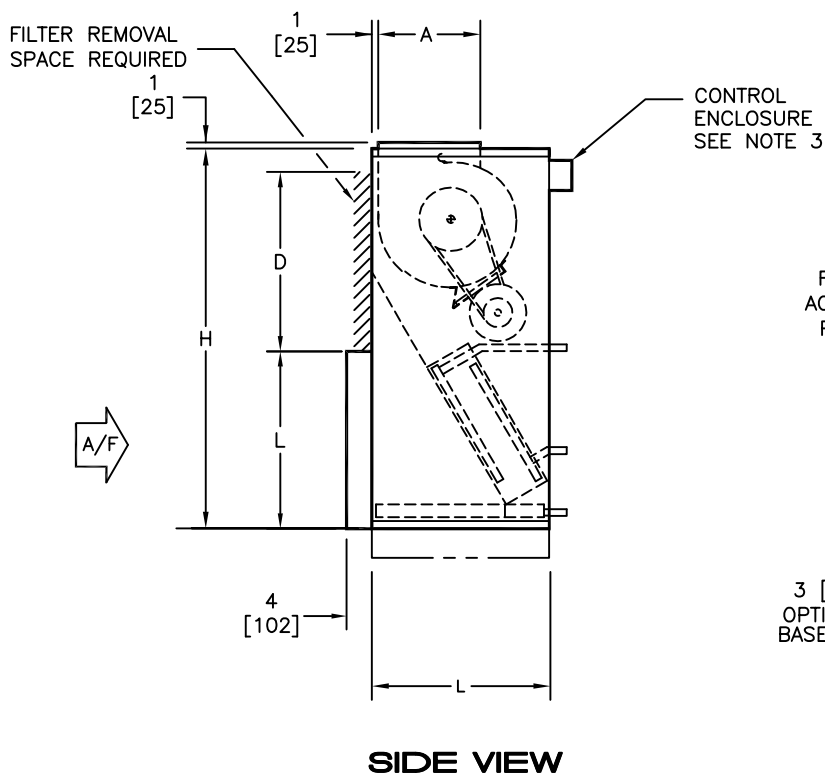
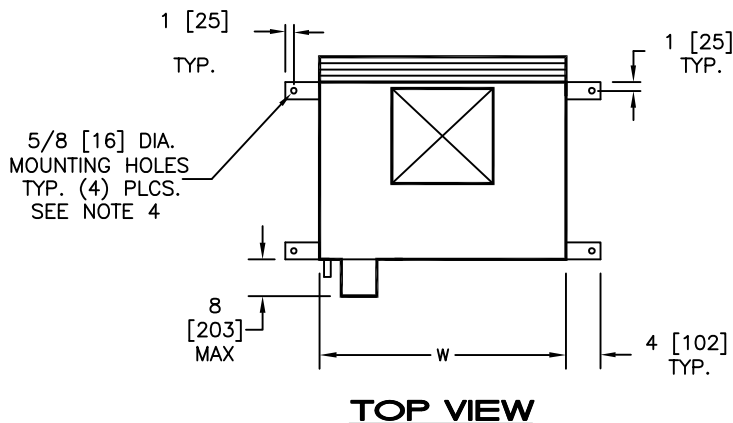

DIMENSIONS - In [mm]

UNIT SIZE	FILTER SIZE	QTY	H	W	L	A	B	C	D
08	16 X 20 X 2 [406 X 508 X 51]	1	46 [1168]	26 [660]	19 [483]	6-1/2 [165]	6-7/8 [175]	9-9/16 [243]	16 [406]
12	20 X 20 X 2 [508 X 508 X 51]	1	46 [1168]	26 [660]	21 [533]	7-1/2 [190]	8-1/4 [210]	8-7/8 [225]	20 [508]
16	24 X 24 X 2 [610 X 610 X 51]	1	54 [1372]	29 [737]	25 [635]	7-1/2 [190]	10-1/4 [260]	9-3/8 [238]	24 [610]
20	24 X 24 X 2 [610 X 610 X 51]	1	54 [1372]	29 [737]	28 [711]	11-3/8 [289]	13-1/4 [337]	7-7/8 [200]	24 [610]
25	24 X 24 X 2 [610 X 610 X 51]	1 EACH	60 [1524]	39 [991]	28 [711]	13-1/2 [343]	12-7/8 [327]	13-1/16 [332]	24 [610]
30	12 X 24 X 2 [305 X 610 X 51]	1 EACH	60 [1524]	39 [991]	28 [711]	15-1/4 [387]	15 [381]	12 [305]	24 [610]

TITLE: MODEL VR SERIES "C"
BELT DRIVE BLOWER COIL UNIT
BASIC UNIT - DISCHARGE ARGT. 1



DRN BY: JCR DATE: 1/30/06 SCALE: NA DRAWING NO.
CKD BY: DPB DATE: 2/10/09 REV: 03

52-80006

THIS DRAWING CONTAINS PROPRIETARY DATA.
UNAUTHORIZED DISCLOSURE, REPRODUCTION, OR USE
IS STRICTLY PROHIBITED WITHOUT WRITTEN PERMISSION

DO NOT SCALE DRAWING
DIMENSIONS AND DATA ARE SUBJECT TO CHANGE WITHOUT NOTICE.
CONTACT FACTORY FOR CERTIFIED DRAWINGS.