

NOTES:

1. All dimensions are Inches [millimeters].
All dimensions are $\pm 1/4"$ [6mm].
Metric values are soft conversion.
2. ENVIRO-TEC will not accept responsibility for unit support based on additional field supplied suspension devices, which are sized and designed by others.

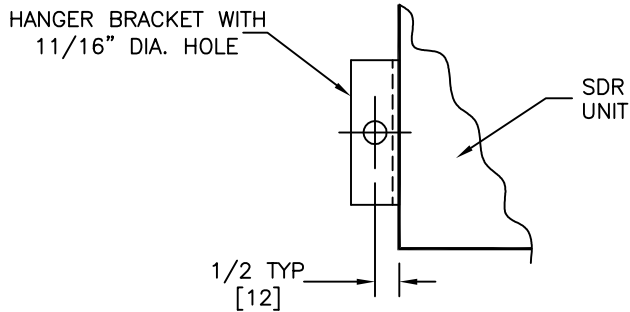

DETAIL "A"

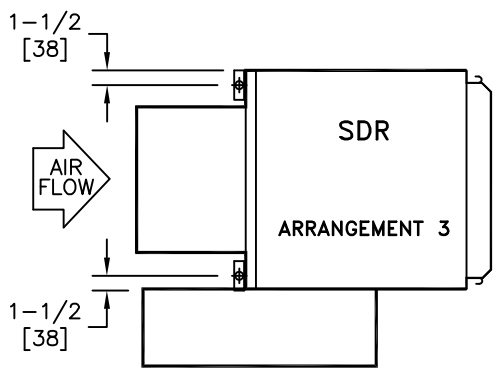
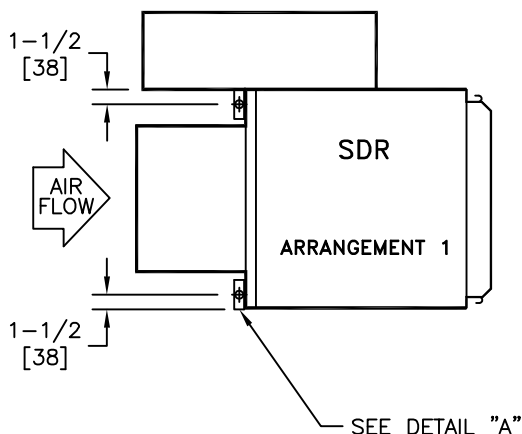

TOP VIEWS

<p>TITLE:</p> <p>MODEL SDR, SDR-SA & SDR-EH SINGLE DUCT TERMINAL UNIT HANGER BRACKET LOCATIONS</p>			
<p>THIS DRAWING CONTAINS PROPRIETARY DATA. UNAUTHORIZED DISCLOSURE, REPRODUCTION, OR USE IS STRICTLY PROHIBITED WITHOUT WRITTEN PERMISSION</p>		<p>DO NOT SCALE DRAWING DIMENSIONS AND DATA ARE SUBJECT TO CHANGE WITHOUT NOTICE. CONTACT FACTORY FOR CERTIFIED DRAWINGS.</p>	
<p>DRN BY: DI</p>	<p>DATE: 6/3/05</p>	<p>SCALE: NTS</p>	<p>DRAWING NO.</p>
<p>CKD BY: HANK</p>	<p>DATE: 6/10/05</p>	<p>REV: 00</p>	<p>01-80049</p>

NOTES:

1. All dimensions are Inches [millimeters].
All dimensions are $\pm 1/4"$ [6mm].
Metric values are soft conversion.
2. ENVIRO-TEC will not accept responsibility for unit support based on additional field supplied suspension devices, which are sized and designed by others.

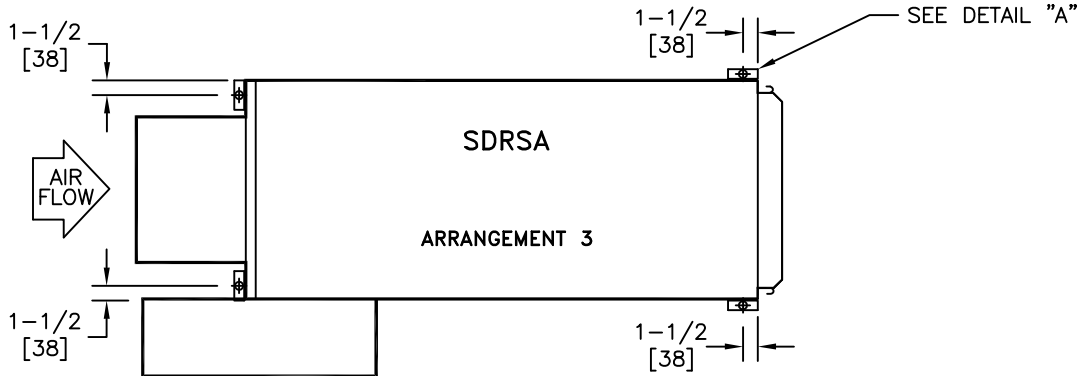
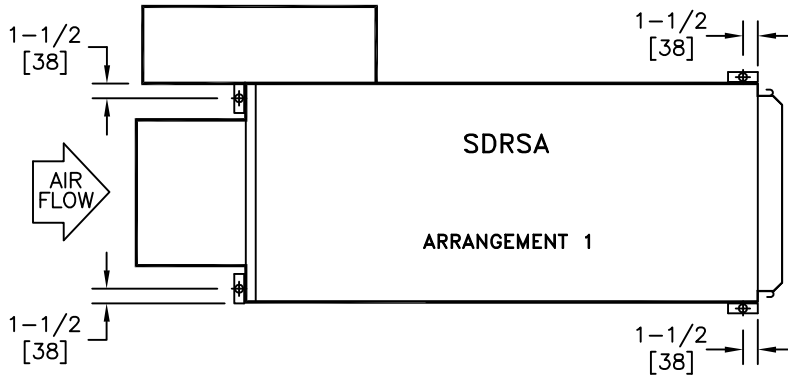
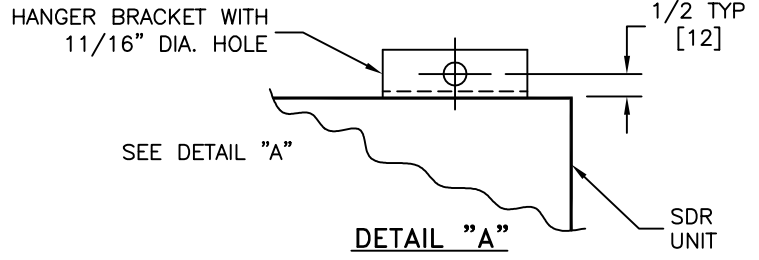

TOP VIEWS

TITLE:
MODEL SDR, SDR-SA & SDR-EH
SINGLE DUCT TERMINAL UNIT
HANGER BRACKET LOCATIONS



DRN BY: DI	DATE: 6/3/05	SCALE: NTS	DRAWING NO.
CKD BY: HANK	DATE: 6/10/05	REV: 00	

01-80049

THIS DRAWING CONTAINS PROPRIETARY DATA.
UNAUTHORIZED DISCLOSURE, REPRODUCTION, OR USE
IS STRICTLY PROHIBITED WITHOUT WRITTEN PERMISSION

DO NOT SCALE DRAWING
DIMENSIONS AND DATA ARE SUBJECT TO CHANGE WITHOUT NOTICE.
CONTACT FACTORY FOR CERTIFIED DRAWINGS.

NOTES:

1. All dimensions are Inches [millimeters].
All dimensions are $\pm 1/4"$ [6mm].
Metric values are soft conversion.
2. ENVIRO-TEC will not accept responsibility for unit support based on additional field supplied suspension devices, which are sized and designed by others.

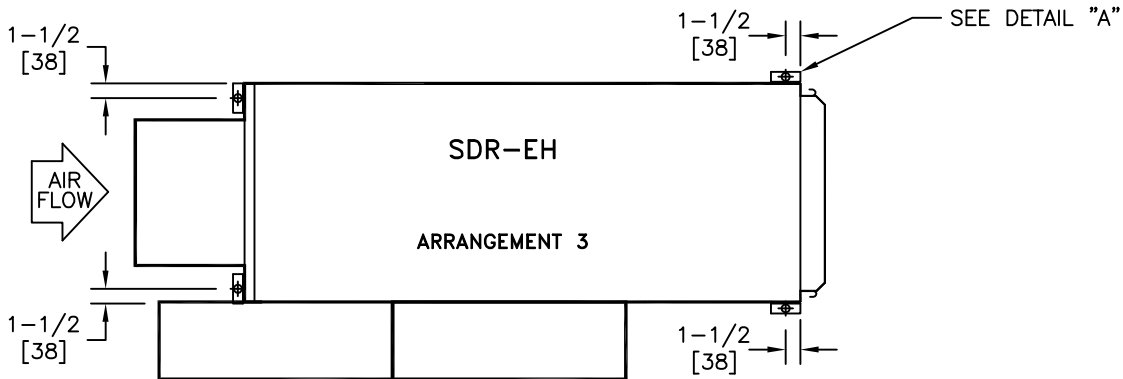
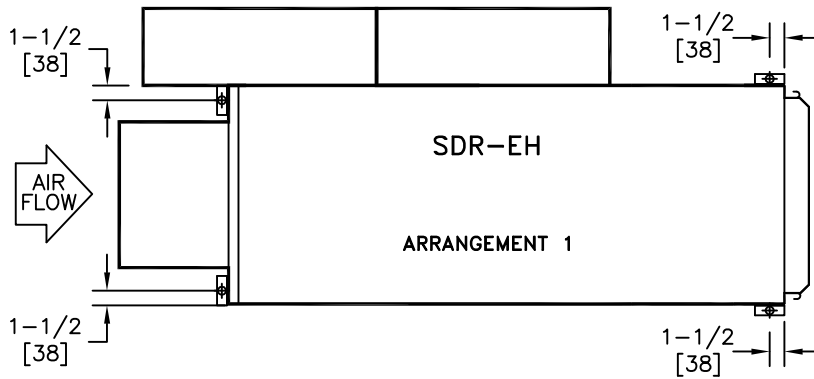
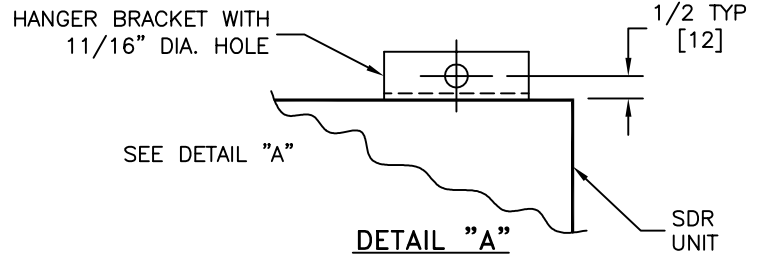

TOP VIEWS

TITLE:
MODEL SDR, SDR-SA & SDR-EH
SINGLE DUCT TERMINAL UNIT
HANGER BRACKET LOCATIONS



DRN BY: DI	DATE: 6/3/05	SCALE: NTS	DRAWING NO.
CKD BY: HANK	DATE: 6/10/05	REV: 00	

01-80049

THIS DRAWING CONTAINS PROPRIETARY DATA.
UNAUTHORIZED DISCLOSURE, REPRODUCTION, OR USE
IS STRICTLY PROHIBITED WITHOUT WRITTEN PERMISSION

DO NOT SCALE DRAWING
DIMENSIONS AND DATA ARE SUBJECT TO CHANGE WITHOUT NOTICE.
CONTACT FACTORY FOR CERTIFIED DRAWINGS.

NOTES:

1. All dimensions are Inches [millimeters].
All dimensions are $\pm 1/4"$ [6mm].
Metric values are soft conversion.
2. ENVIRO-TEC will not accept responsibility for unit support based on additional field supplied suspension devices, which are sized and designed by others.

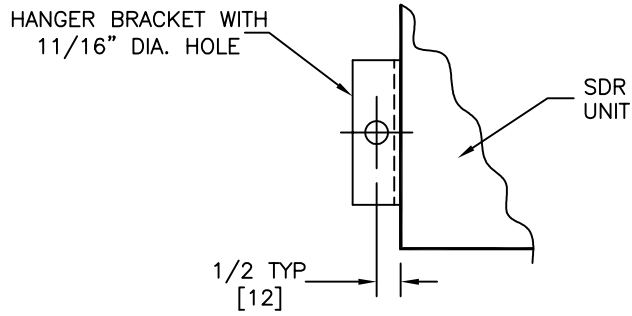

DETAIL "A"

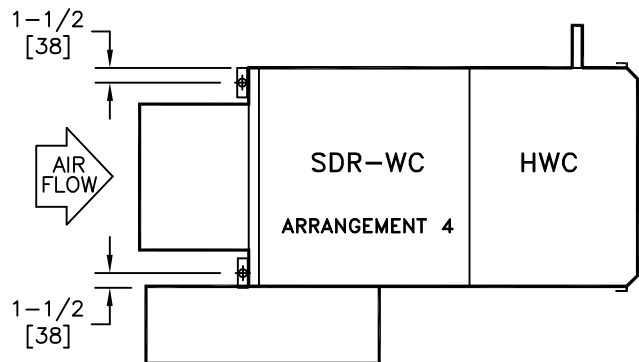
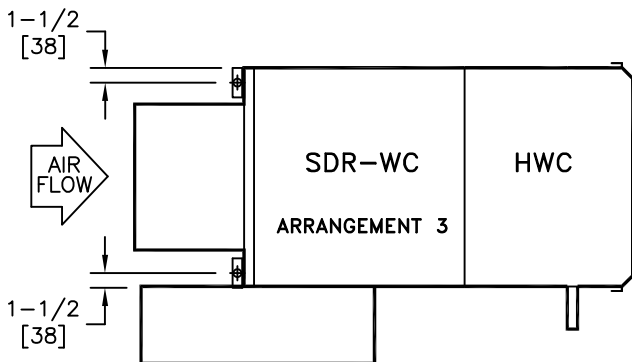
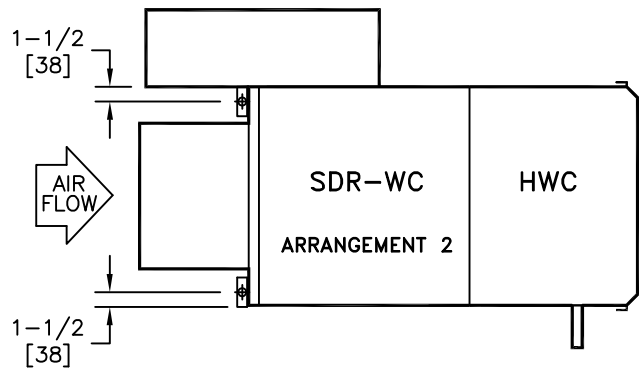
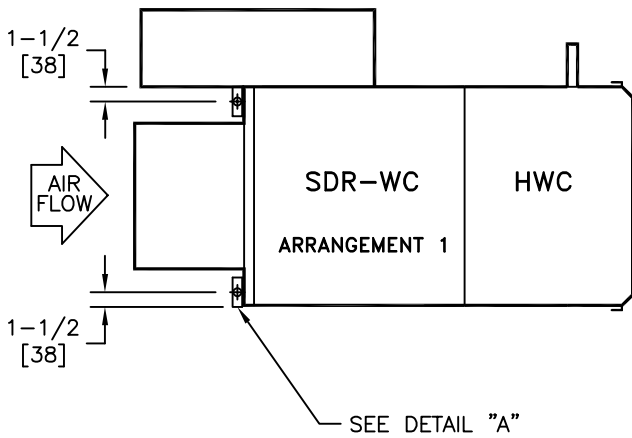

TOP VIEWS

TITLE: MODEL SDR, SDR-SA & SDR-EH SINGLE DUCT TERMINAL UNIT HANGER BRACKET LOCATIONS			
DRN BY: DI	DATE: 6/3/05	SCALE: NTS	DRAWING NO.
CKD BY: HANK	DATE: 6/10/05	REV: 00	01-80049

THIS DRAWING CONTAINS PROPRIETARY DATA. UNAUTHORIZED DISCLOSURE, REPRODUCTION, OR USE IS STRICTLY PROHIBITED WITHOUT WRITTEN PERMISSION

DO NOT SCALE DRAWING. DIMENSIONS AND DATA ARE SUBJECT TO CHANGE WITHOUT NOTICE. CONTACT FACTORY FOR CERTIFIED DRAWINGS.

NOTES:

- All dimensions are Inches [millimeters].
All dimensions are $\pm 1/4"$ [6mm].
Metric values are soft conversion.
- ENVIRO-TEC will not accept responsibility for unit support based on additional field supplied suspension devices, which are sized and designed by others.

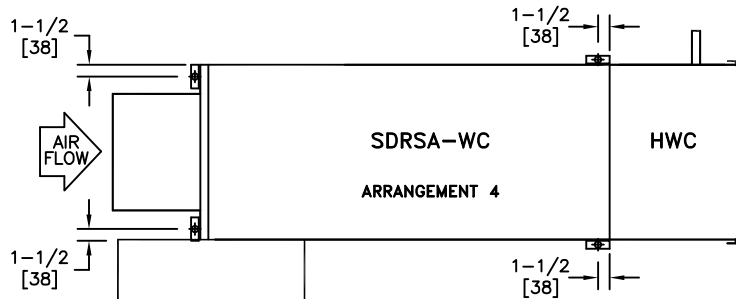
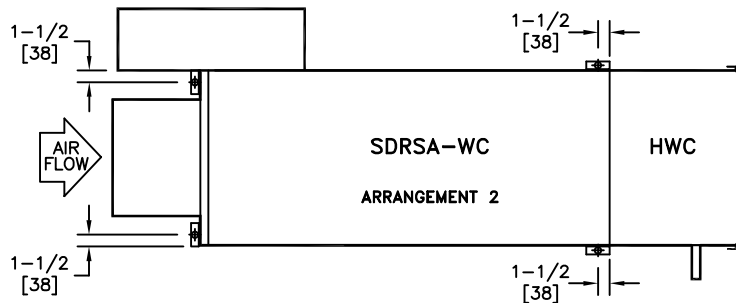
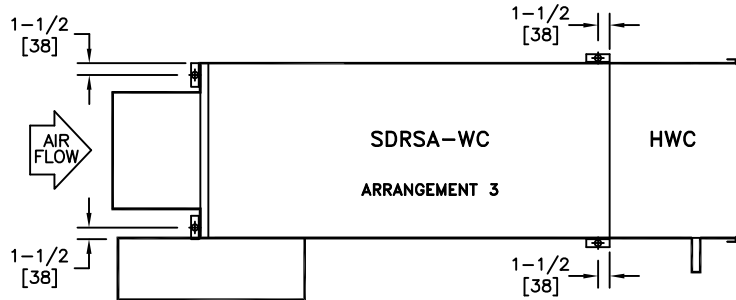
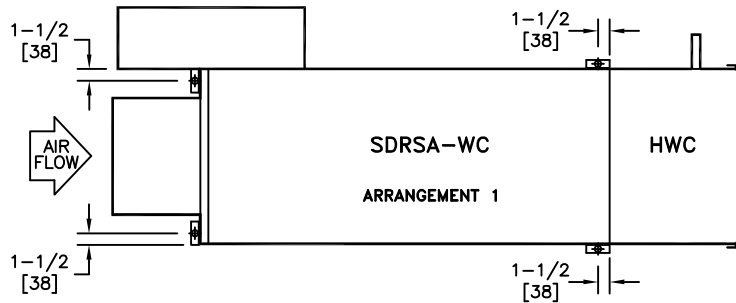
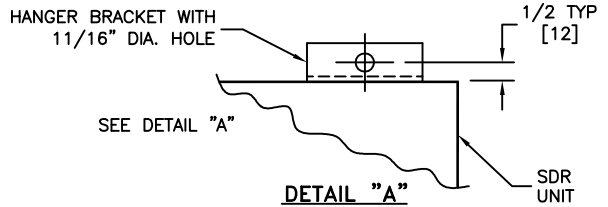

TOP VIEWS

<p>TITLE:</p> <p>MODEL SDR, SDR-SA & SDR-EH SINGLE DUCT TERMINAL UNIT HANGER BRACKET LOCATIONS</p>			<p>DRN BY: DI</p>	<p>DATE: 6/3/05</p>	<p>SCALE: NTS</p>	<p>DRAWING NO.</p>
			<p>CKD BY: HANK</p>	<p>DATE: 6/10/05</p>	<p>REV: 00</p>	<p>01-80049</p>
<p>THIS DRAWING CONTAINS PROPRIETARY DATA. UNAUTHORIZED DISCLOSURE, REPRODUCTION, OR USE IS STRICTLY PROHIBITED WITHOUT WRITTEN PERMISSION</p>		<p>DO NOT SCALE DRAWING DIMENSIONS AND DATA ARE SUBJECT TO CHANGE WITHOUT NOTICE. CONTACT FACTORY FOR CERTIFIED DRAWINGS.</p>				