

T-Bar Configurations

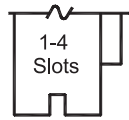

LT0
No Tee Bars

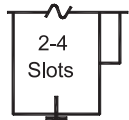

LT1
Center Tees only,
no outside Tees

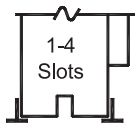

LT2
Tees on both
sides

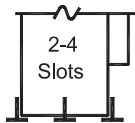

LT3
All Tees

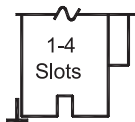

LT4
Tee opposite
inlet

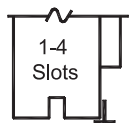

LT5
Tee on inlet
side

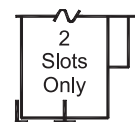

LT6
Tees center and
opposite inlet

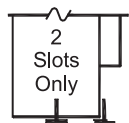

LT7
Tees center and
inlet side

PF Frame Details

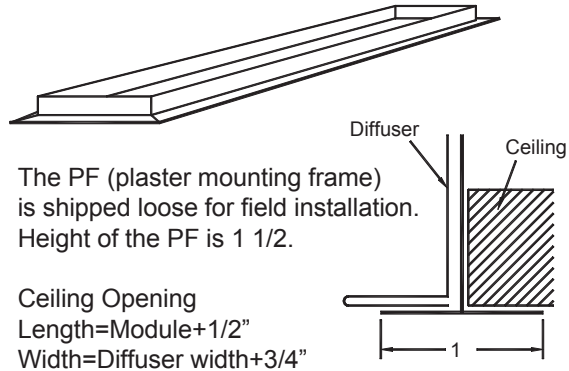

CN (cross notch) Detail

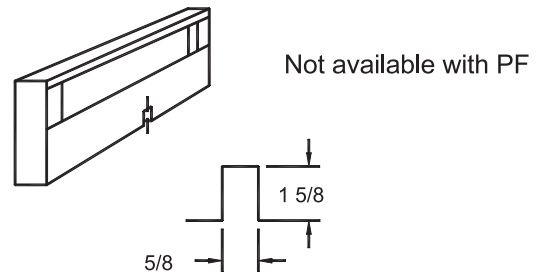

ID (inlet damper) Detail

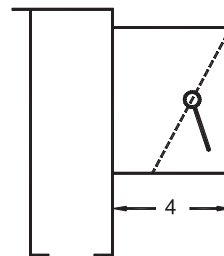

Mounting Tab Detail

MO (mtg. tab opposite inlet) shown
MB (mtg. tab on both sides)

