

NOTES:

1. All dimensions are Inches [millimeters].
All dimensions are $\pm 1/4"$ [6mm]. Metric values are soft conversion.
2. Right hand unit shown, left hand unit opposite.
Motor/drive location may be specified Left or Right Hand. Standard control enclosure location matches motor/drive position.
3. Provide sufficient clearance to permit access to controls and comply with applicable codes and ordinances.
4. See drawing FR-001 for filter rack details.
5. Base rail is optional on the base unit. See drawing BR-001. Base rails must be used with mixing box.
6. See coil connection detail drawings for coil connection sizes and locations.

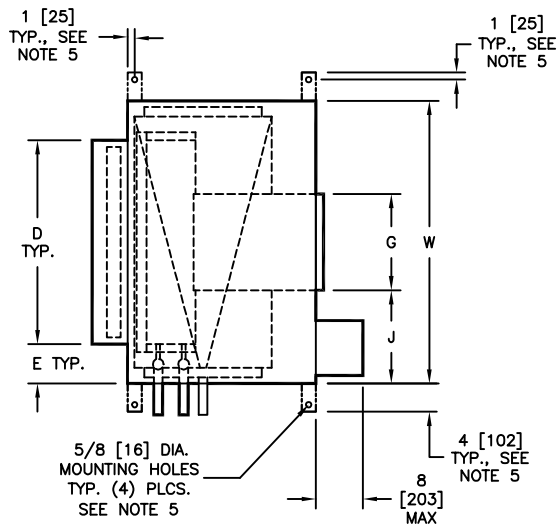

TOP VIEW

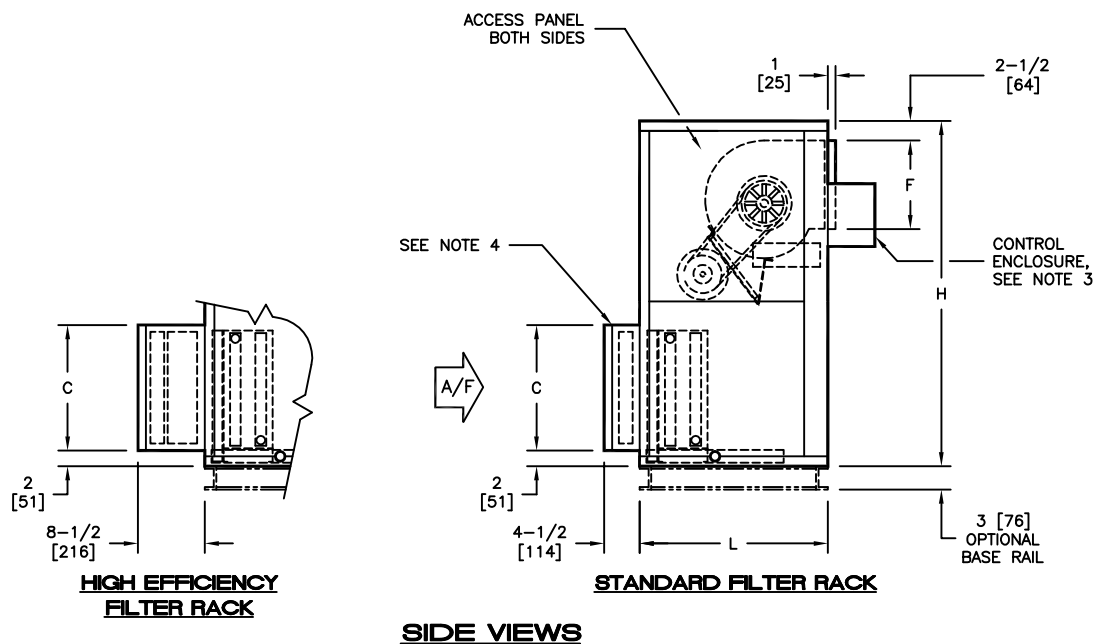

SIDE VIEWS

DIMENSIONS

SIZE	FAN SIZE	L	W	H	C	D	E	F	G	J
08	9 X 4 [229 X 102]	24 [610]	30 [762]	44 [1118]	16 [406]	20 [508]	5 [127]	10-1/4 [260]	6-7/8 [175]	11-9/16 [294]
12	9 X 6 [229 X 152]	24 [610]	36 [914]	44 [1118]	16 [406]	25 [635]	5-1/2 [140]	10-1/4 [260]	8-1/4 [210]	13-7/8 [352]
16	10 X 8 [254 X 203]	24 [610]	44 [1118]	44 [1118]	16 [406]	39-1/2 [1003]	2-1/4 [57]	13-1/2 [343]	10-1/4 [260]	16-7/8 [429]
20	10 X 10 [254 X 254]	30 [762]	50 [1270]	50 [1270]	16 [406]	44-1/2 [1130]	2-3/4 [70]	13-1/2 [343]	13-1/4 [337]	18-3/8 [467]
30	15 X 9 [381 X 229]	30 [762]	59 [1499]	56 [1422]	25 [635]	51 [1295]	4 [102]	16 [406]	13-1/4 [337]	22-7/8 [581]
40	15 X 11 [381 X 279]	30 [762]	68 [1727]	59 [1499]	25 [635]	59 [1499]	4-1/2 [114]	16 [406]	15 [381]	26-1/2 [673]

TITLE: MODEL V SERIES C
BELT DRIVE BLOWER COIL UNIT
BASIC UNIT - DISCHARGE ARG. 3



DRN BY: JGH	DATE: 3/6/14	SCALE: NTS	DRAWING NO.
CKD BY: DPB	DATE: 3/6/14	REV: 01	

37-80002

THIS DRAWING CONTAINS PROPRIETARY DATA.
UNAUTHORIZED DISCLOSURE, REPRODUCTION, OR USE
IS STRICTLY PROHIBITED WITHOUT WRITTEN PERMISSION

DO NOT SCALE DRAWING
DIMENSIONS AND DATA ARE SUBJECT TO CHANGE WITHOUT NOTICE.
CONTACT FACTORY FOR CERTIFIED DRAWINGS.